



XQ-Deluxe Series

Digital Video Recorder

USER'S MANUAL





WARNING

**RISK OF ELECTRIC SHOCK
DO NOT OPEN**



**WARNING: TO REDUCE THE RISK OF ELECTRIC SHOCK,
DO NOT REMOVE COVER (OR BACK).
NO USER-SERVICEABLE PARTS INSIDE.**



The lightning flash with arrowhead symbol, within an equilateral triangle, is intended to alert the user to the presence of uninsulated "dangerous voltage" within the product's enclosure that may be of sufficient magnitude to constitute a risk of electric shock.



The exclamation point within an equilateral triangle is intended to alert the user to the presence of important operating and Maintenance (servicing) instructions in the literature accompanying the appliance.

COMPLIANCE NOTICE OF FCC:

THIS EQUIPMENT HAS BEEN TESTED AND FOUND TO COMPLY WITH THE LIMITS FOR A CLASS A DIGITAL DEVICE, PURSUANT TO PART 15 OF THE FCC RULES. THESE LIMITS ARE DESIGNED TO PROVIDE REASONABLE PROTECTION AGAINST HARMFUL INTERFERENCE WHEN THE EQUIPMENT IS OPERATED IN A COMMERCIAL ENVIRONMENT. THIS EQUIPMENT GENERATES, USES, AND CAN RADIATE RADIO FREQUENCY ENERGY AND IF NOT INSTALLED AND USED IN ACCORDANCE WITH THE INSTRUCTION MANUAL, MAY CAUSE HARMFUL INTERFERENCE TO RADIO COMMUNICATIONS. OPERATION OF THIS EQUIPMENT IN A RESIDENTIAL AREA IS LIKELY TO CAUSE HARMFUL INTERFERENCE, IN WHICH CASE USERS WILL BE REQUIRED TO CORRECT THE INTERFERENCE AT THEIR OWN EXPENSE.

CAUTION: CHANGES OR MODIFICATIONS NOT EXPRESSLY APPROVED BY THE PARTY RESPONSIBLE FOR COMPLIANCE COULD VOID THE USER'S AUTHORITY TO OPERATE THE EQUIPMENT. THIS CLASS OF DIGITAL APPARATUS MEETS ALL REQUIREMENTS OF THE CANADIAN INTERFERENCE-CAUSING EQUIPMENT REGULATIONS.

The information in this manual is believed to be accurate as of the date of publication. The information contained herein is subject to change without notice. Revisions or new editions to this publication may be issued to incorporate such changes.

IMPORTANT SAFEGUARDS

1. Read Instructions

All the safety and operating instructions should be read before the appliance is operated.

2. Retain Instructions

The safety and operating instructions should be retained for future reference.

3. Cleaning

Unplug this equipment from the wall outlet before cleaning it. Do not use liquid aerosol cleaners. Use a damp soft cloth for cleaning.

4. Attachments

Never add any attachments and/or equipment without the approval of The manufacturer as such additions may result in the risk of fire, electric shock or other personal injury.

5. Water and/or Moisture

Do not use this equipment near water or in contact with water.

6. Accessories

Do not place this equipment on an unstable cart, stand or table. The equipment may fall, causing serious injury to a child or adult, and serious damage to the equipment. Wall or shelf mounting should follow the manufacturer's instructions, and should use a mounting kit approved by the manufacturer.

7. Power Sources

This equipment should be operated only from the type of power source indicated on the marking label. If you are not sure of the type of power, please consult your equipment dealer or local power company.

8. Power Cords

Operator or installer must remove power and TNT connections before handling the equipment.

9. Lightning

For added protection for this equipment during a lightning storm, or when it is left unattended and unused for long periods of time, unplug it from the wall outlet and disconnect the antenna or cable system. This will prevent damage to the equipment due to lightning and power-line surges.

10. Overloading

Do not overload wall outlets and extension cords as this can result in the risk of fire or electric shock.

11. Objects and Liquids

Never push objects of any kind through openings of this equipment as they may touch dangerous voltage points or short out parts that could result in a fire or electric shock. Never spill liquid of any kind on the Equipment.

12. Servicing

Do not attempt to service this equipment yourself. Refer all servicing to qualified service personnel.

13. Damage requiring Service

Unplug this equipment from the wall outlet and refer servicing to qualified service personnel under the following conditions:

A. When the power-supply cord or the plug has been damaged.

B. If liquid is spilled, or objects have fallen into the equipment.

C. If the equipment has been exposed to rain or water.

D. If the equipment does not operate normally by following the operating instructions, adjust only those controls that are covered by the operating instructions as an improper adjustment of other controls may result in damage and will often require extensive work by a qualified technician to restore the equipment to its normal operation.

E. If the equipment has been dropped, or the cabinet damaged.

F. When the equipment exhibits a distinct change in performance — this indicates a need for service.

14. Replacement Parts

When replacement parts are required, be sure the service technician has used replacement parts specified by the manufacturer or that have the same characteristics as the original part. Unauthorized substitutions may result in fire, electric shock or other hazards.

15. Safety Check

Upon completion of any service or repairs to this equipment, ask the service technician to perform safety checks to determine that the equipment is in proper operating condition.

16. Field Installation

This installation should be made by a qualified service person and should conform to all local codes.

17. Correct Batteries

Warning: Risk of explosion if battery is replaced by an incorrect type. Dispose of used batteries according to the instructions.

18. Tmra

A manufacturer's maximum recommended ambient temperature (Tmra) for the equipment must be specified so that the customer and installer may determine a suitable maximum operating environment for the equipment.

19. Elevated Operating Ambient Temperature

If installed in a closed or multi-unit rack assembly, the operating ambient temperature of the rack environment may be greater than room

ambient. Therefore, consideration should be given to installing the equipment in an environment compatible with the manufacturer's maximum rated ambient temperature (Tmra).

20. Reduced Air Flow

Installation of the equipment in the rack should be such that the amount of airflow required for safe operation of the equipment is not compromised.

21. Mechanical Loading

Mounting of the equipment in the rack should be such that a hazardous condition is not caused by uneven mechanical loading.

22. Circuit Overloading

Consideration should be given to connection of the equipment to supply circuit and the effect that overloading of circuits might have on over current protection and supply wiring. Appropriate consideration of equipment nameplate ratings should be used when addressing this concern.

23. Reliable Earthing (Grounding)

Reliable grounding of rack mounted equipment should be maintained. Particular attention should be given to supply connections other than direct connections to the branch circuit (e.g., use of power strips).



INDEX

1. SAFETY CAUTIONS	6
1.1 Power Source	6
1.2 Installation	6
1.3 Cleaning and Usage	7
2. OUTLINE	8
2.1 Functions	8
2.2 System Organization	9
3. DVR ORGANIZATION	10
3.1 Front Panel	10
3.2 Real Panel	14
3.3 Remote Controller	16
4. LIVE	17
4.1 Live Screen	17
4.1.1 Top Menu	18
4.1.2 Bottom Menu	18
4.1.3 CAMEO Menu	19
5. SETUP	22
5.1 SYSTEM SETUP	22
5.1.1 GENERAL	23
5.1.2 ALARM OUT	24
5.1.3 DISK	24
5.1.4 MONITOR	26
5.1.5 ACCOUT	27
5.1.6 CONFIG	28
5.1.7 SHUTDOWN	29





INDEX

5.2 DEVICE SETUP	-----	30
5.2.1 CAMERA	-----	30
3.2.2 PTZ	-----	31
5.2.3 SPOT	-----	32
5.2.4 SEQUENCE	-----	33
5.2.5 PRIVATE ZONE	-----	34
5.3 EVENT SETUP	-----	35
5.3.1 MOTION	-----	35
5.3.2 ALARM IN	-----	38
5.3.3 VIDEO LOSS	-----	39
5.3.4 SYSTEM	-----	40
5.3.5 DISPLAY	-----	41
5.4 RECORD SETUP	-----	42
5.4.1 RESOLUTION	-----	42
5.4.2 SCHEDULE & RECORD	-----	43
5.4.3 AUDIO	-----	45
5.4.4 MANUAL	-----	45
5.5 NETWORK SETUP	-----	46
5.5.1 NETWORK	-----	46
5.5.2 SERIAL	-----	48
5.5.3 DDNS	-----	49
5.5.4 E-MAIL	-----	50
5.6 SYSTEM INFORMATION	-----	51
5.6.1 SYSTEM LOG	-----	51
5.6.2 STATUS	-----	52
5.6.3 VERSION	-----	53





INDEX

- 6. SEARCH** ----- 54
 - 6.1 Search Screen** ----- 55
 - 6.1.1 Search Menu ----- 56
 - 6.1.2 Calendar Search ----- 56
 - 6.1.3 Event Search ----- 57
 - 6.1.4 Overlapped List ----- 58
 - 6.1.5 Panorama Search ----- 59
 - 6.1.6 Smart Search ----- 59
 - 6.1.7 Section Repeat Search ----- 60
- 7. BACKUP** ----- 62
 - 7.1 Playback with backup data ----- 63
- 8. APPENDIX** ----- 64
 - 8.1 Specification ----- 64
 - 8.2 Trouble Shooting ----- 65



1. SAFETY CAUTIONS

- ※ Follow these instructions to keep the user safe and prevent property damage.
Read them carefully before the use of the product.
The responsibility falls on the user to install and use the product properly.

1.1 Power Source-related

- ① Insert the power plug fully and firmly into the power source.
– Unstable connection may cause fire.



- ② Do not use a damaged power cord, plug or loose outlet.
– It may cause electric shock or fire.



- ③ Do not plug several devices exceeding the rated capacity into a single outlet.
– Abnormal heat generation at the outlet may cause fire.

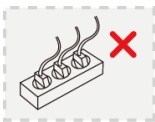

- ④ Do not bend nor pull the power cord. Do not place a heavy object on top of it.
– It may cause electric shock or fire.

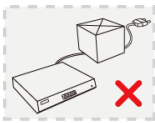

- ⑤ When unplugging the power cord, do not pull it out by touching the cord area or do not touch it with a wet hand.
– It may cause electric shock or fire.



1.2 Installation-related

- ① Do not place candlelight or cigarette light on top of the product or do not install the product near heating devices.
– It may cause fire.



- ② Do not place the power cord near heating devices.
– The exterior of the cord may be peeled off, causing electric shock or fire.



- ③ Do not install the product in a place where a large amount of oil, smoke or moisture exists. Do not install the product in a vehicle or a place where water is splashed.
– It may cause electric shock or fire.



- ④ Do not place the product on top of an unstable cart, stand or table. Do not block the air ventilation with table cloth or curtain.
– Internal temperature rise may cause fire.



- ⑤ Do not install the product in a narrow place. Keep the product a certain distance away from the wall.
– Internal temperature rise may cause fire.



1.3 Cleaning and Usage-related

- ① Unplug the power plug during lightning, thunderstorm or when not in use for long periods of time.
- It may cause electric shock or fire.



- ② When taking the battery out from the remote control, keep them away from children to prevent from swallowing incidents. Keep the battery away from babies.
- If a child swallowed the battery, immediately consult a doctor.



- ③ Do not place the container or base filled with water, liquids, chemicals, small piece of metal and heavy object on the product.
- If liquid flows into the product, it may cause electric shock or fire. A heavy object may drop from the top of the product, causing injury.



- ④ Do not use or store the product near combustible sprays and other flammable substances.
- It may cause explosion or fire.



- ⑤ If dust or water is present at the power plug's pin and contact area, wipe out the area.
- may cause electric shock or fire.



- ⑥ When cleaning the product, unplug the power cord and gently wipe using a soft cloth. Do not directly spray water on the product or do not use benzene, thinner or alcohol when cleaning.
- It may cause electric shock or fire.



- ⑦ When replacing the battery, be sure to check the correctness of the polarity (+,-).
- If the battery polarity is wrong, generation of abnormal heat or leakage of internal liquid may cause fire, injury or contamination in the surrounding area.



- ⑧ In case the product was dropped or the case was damaged, switch off the product and unplug the power cord. Have a technician repair the product.
- If the damaged product is used without repair, it may cause electric shock.



- ⑨ Do not repair or disassemble the product by yourself or do not connect other connection devices without the manufacturer's approval.
- If repair is required, contact the reseller. Failure to follow this instruction may cause electric shock or fire.





2. OUTLINE

2.1 Functions

This DVR provide superior video image quality on Live view and Playback.

- Pentaplex Operation Performance (Live, Recording, Playback, Backup, Network)
- Up to maximum 16 channel composite input ports depending on model.
- Various Recording mode. (Manual / Schedule / Event)
- Various Search functions. (Date/Hour search, Calendar search, Event Search)
- Various Playback functions. (Normal / Fast / Slow / Step / Reverse / Smart / Panorama / Repeat)
- Overwrite Recording function.
- The DVR menu structure and on screen display is presented in a simple to use and logical GUI format.
- Support 16channel Audio.
- Support Mouse control.
- E-mail function (Alarm, Motion detection, Video loss, HDD fail and etc.)

2.2 System Organization

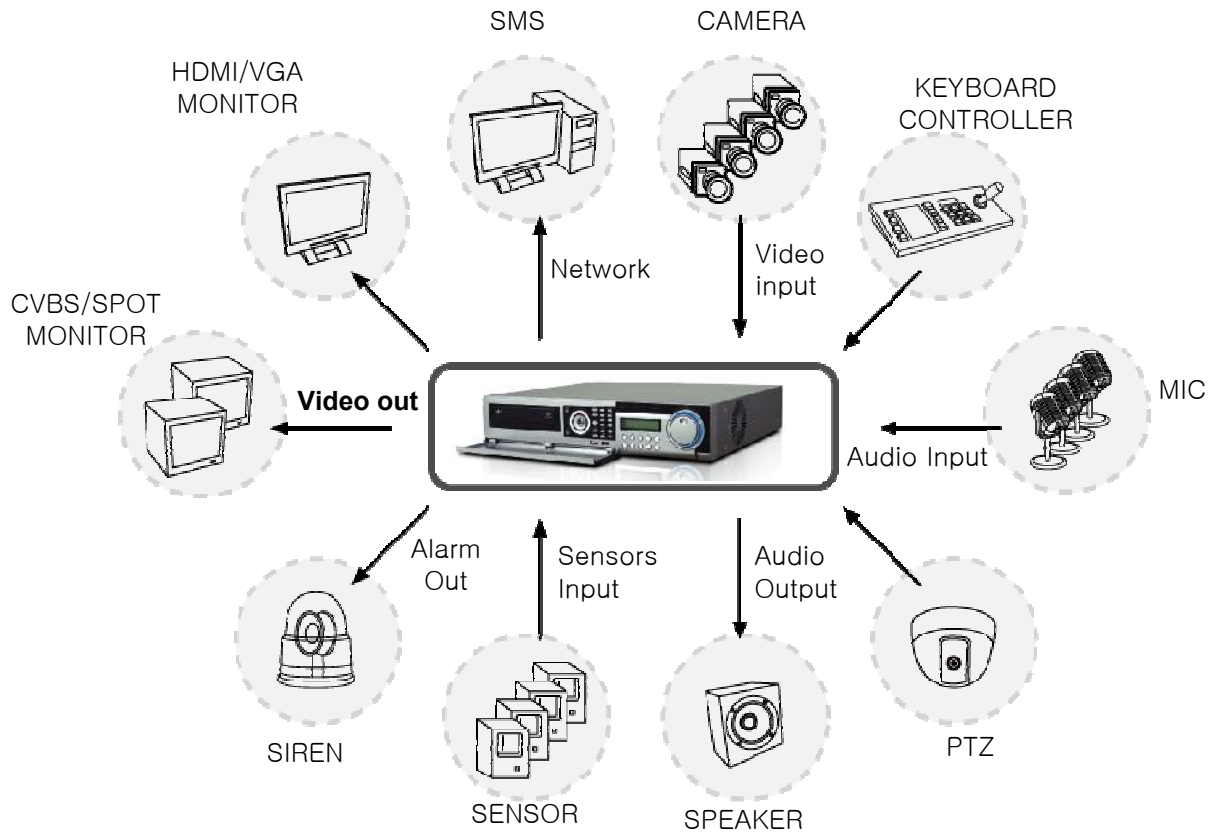

3. DVR ORGANIZATION

3.1 Front Panel Description

NOTE: Turn on the DVR after connecting the power cord, camera input and monitor completely

▪ Front panel

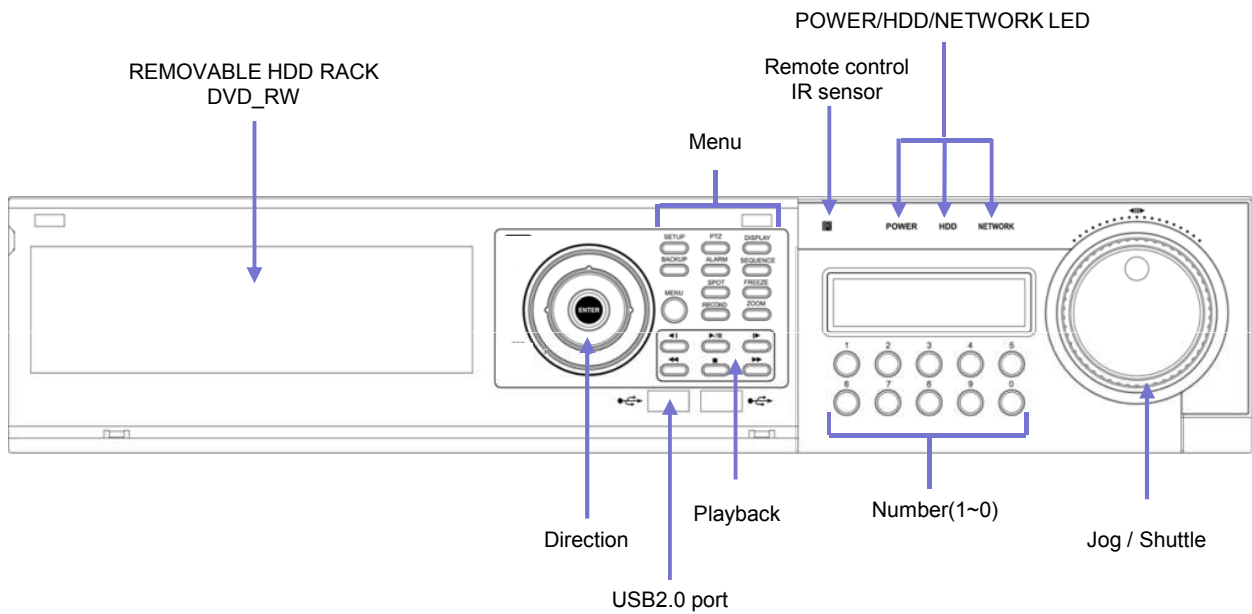

※ Front LED

HDD LED

HDD LED is turned on when DVR is recording.

Network LED

Network LED is turned on when DVR is connected by network.



※ Front Button

The front panel of DVR is similar as normal VCR or Multiplexer and the functions are also similar . Front buttons have various functions and are used for DVR initial setting and others. Please refer to the below explanation.

NUMBER buttons (0 ~ 9)

Displayed selected camera number to full screen.
And also these buttons are used to enter a password.

DISPLAY button

Display split screens 1, 4, 7, 9, 10, 13, 16.

REC button

Start recording when this button is pressed in live mode.

SETUP button

Enter Setup menu. User need to Admin access permission.
Return to previous screen if this button is pressed again.

PTZ Button

Enter PTZ menu. User need to Admin access permission.
PTZ operation is enabled by function button. (PAN/TILT, ZOOM, FOCUS and IRIS)

DISPLAY button

Display split screens 1, 4, 7, 9, 10, 13, 16.

BACKUP button (Zoom)

Enter Backup menu. Return to previous screen if this button is pressed again.
In PTZ mode, it is used Zoom function button.

Alarm button

Enter Alarm out Setup menu. User need to Admin access permission.

SEQUENCE button (Preset)

Display next channel if this button is pressed.
In PTZ mode, It is used Preset function button.

ESC button

Exit current screen or return to previous screen.



SPOT button

Enter Sport Monitor Setup menu. User need to Admin access permission.

FREEZE button

Freeze the current Live displaying

RECORD button

Start recording when this button is pressed in live mode.

Zoom Button

Zoom x 2 , Display is moved by direction button.

▶ in Search area, button (Focus)

Enter Search menu. The password is required for search.
Return to previous screen if this button is pressed again.
In PTZ menu, it is used Focus function button.

■ in Search Area, button (IRIS)

In Search mode, Exit Playback mode.
In PTZ mode, it is used IRIS function button.

ENTER button

Execute the selected button or save the setup value.

ESC Button

Exit current screen or return to previous screen.

BACKUP button

Enter Backup menu. Return to previous screen if this button is pressed again.
In PTZ Mode, it is used Zoom function button.

Direction Buttons (▲, ▼, ◀, ▶)

This buttons are used when move to other menu or change the position of the CAMEO screen.
In PTZ mode, it is used PAN/TILT function.

- ▲ : In Playback mode, it is Panorama search function button.
In PTZ mode, it is used to move the camera to up.
- ▼ : In Playback mode, it is Smart search function button.
In PTZ mode, it is used to move the camera to down.
- ◀ : In Playback mode, it is reverse play button and when paused screen,
user can see each frame if this button is pressed manually.
In PTZ mode, it is used to move the camera to left.
- ▶ : In Playback mode, it is forward play button and when paused screen,
use can see each frame if this button is pressed manually.
In PTZ mode, it is use to move to camera to right.

NOTE: For the Smart search, recording data should be recorded by the Event recording.
Otherwise, if user try to playback with Smart search, the screen is returned to live mode.

FAST REVERSE PLAY button (PTZ)

Playback with fast reverse. Playback speed is changed if this button is pressed repeatedly.
(◀, ◀◀, ◀◀◀, ◀◀◀◀, ◀◀◀◀◀). In PTZ mode, it is used to Zoom out function button.
In live mode, switch to PTZ mode by this button.

FAST FORWARD PLAY button (PLAY)









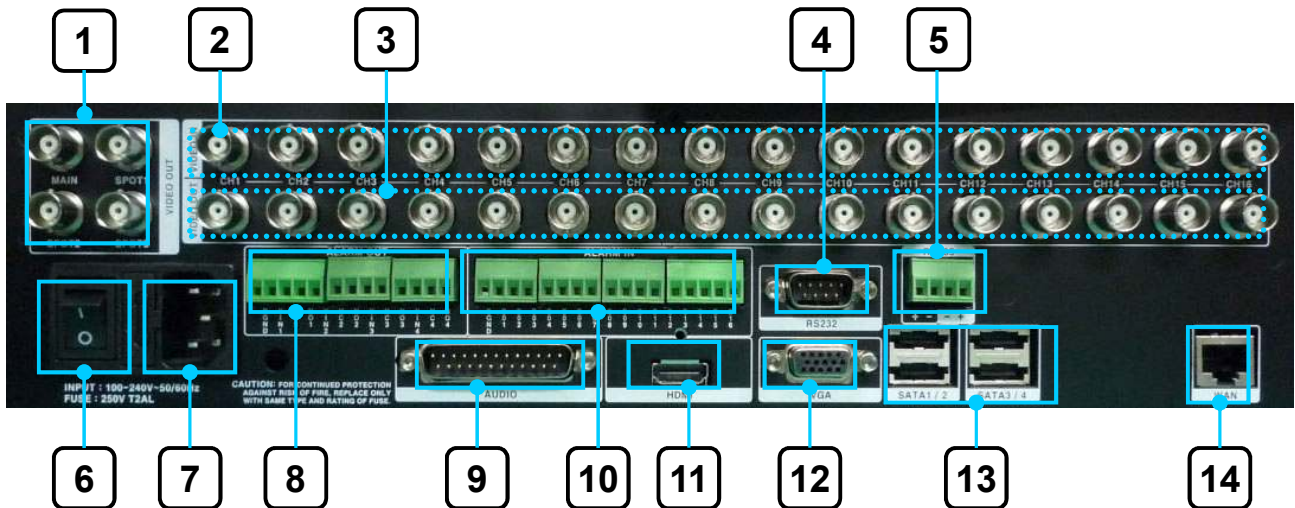





Playback with fast forward. Playback speed is changed if this button is pressed repeatedly.
(▶, ▶▶, ▶▶▶, ▶▶▶▶, ▶▶▶▶▶). In PTZ mode, it is used to Zoom in function button.
In live mode, the last portion of recorded video is played.

※ USB 2.0 Port

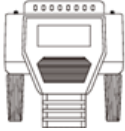
For USB mouse ,firmware upgrade and data backup by inserting USB memory stick with this port.

3.2 Real Panel



<p>1</p>  <p>1 CVBS out 3 Spot out</p>	<p>2</p>  X 16 <p>Analog camera Input</p>	<p>3</p>  <p>16 Loop out</p>	<p>4</p>  <p>RS-232</p>	<p>5</p>  <p>PTZ RS-485</p>
<p>6</p>  <p>Power On/off Switch</p>	<p>7</p>  <p>AC Inlet</p>	<p>8</p>  <p>4 Alarm out</p>	<p>9</p>  <p>16 Audio in 1 Audio out</p>	<p>10</p>  <p>16 Sensor Input</p>
<p>11</p>  <p>HDMI Monitor Out</p>	<p>12</p>  <p>VGA out (Option)</p>	<p>13</p>  <p>4 e-SATA</p>	<p>14</p>  <p>Network</p>	

3.3 Remote Controller

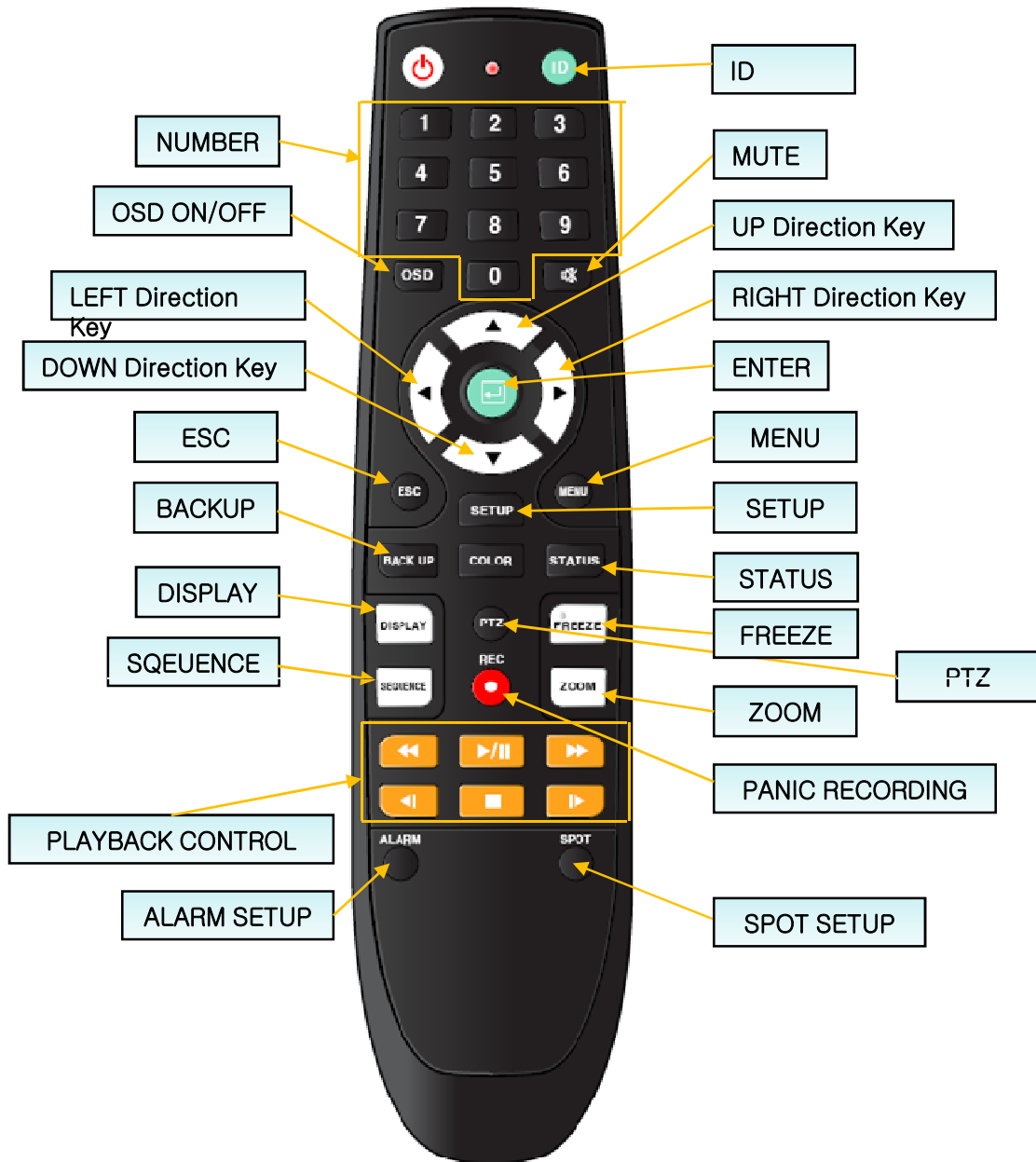

※ **How to set ID**

- ① Before setup the ID, Enter to the GENERAL SETUP and set the ID first. (Default is 0)
- ② While pressing and holding the ID button, enter the unit address of the DVR by two-digit.
- ③ If the unit address is a single digit, enter two digit number by adding the number 0 as the first digit.
(Example – If the unit address is 1, the input value is 01.)

※ **A single remote controller can change ID from 0 to 19 and independently control up to 20 DVRs.**

4. LIVE

4.1 Live Screen

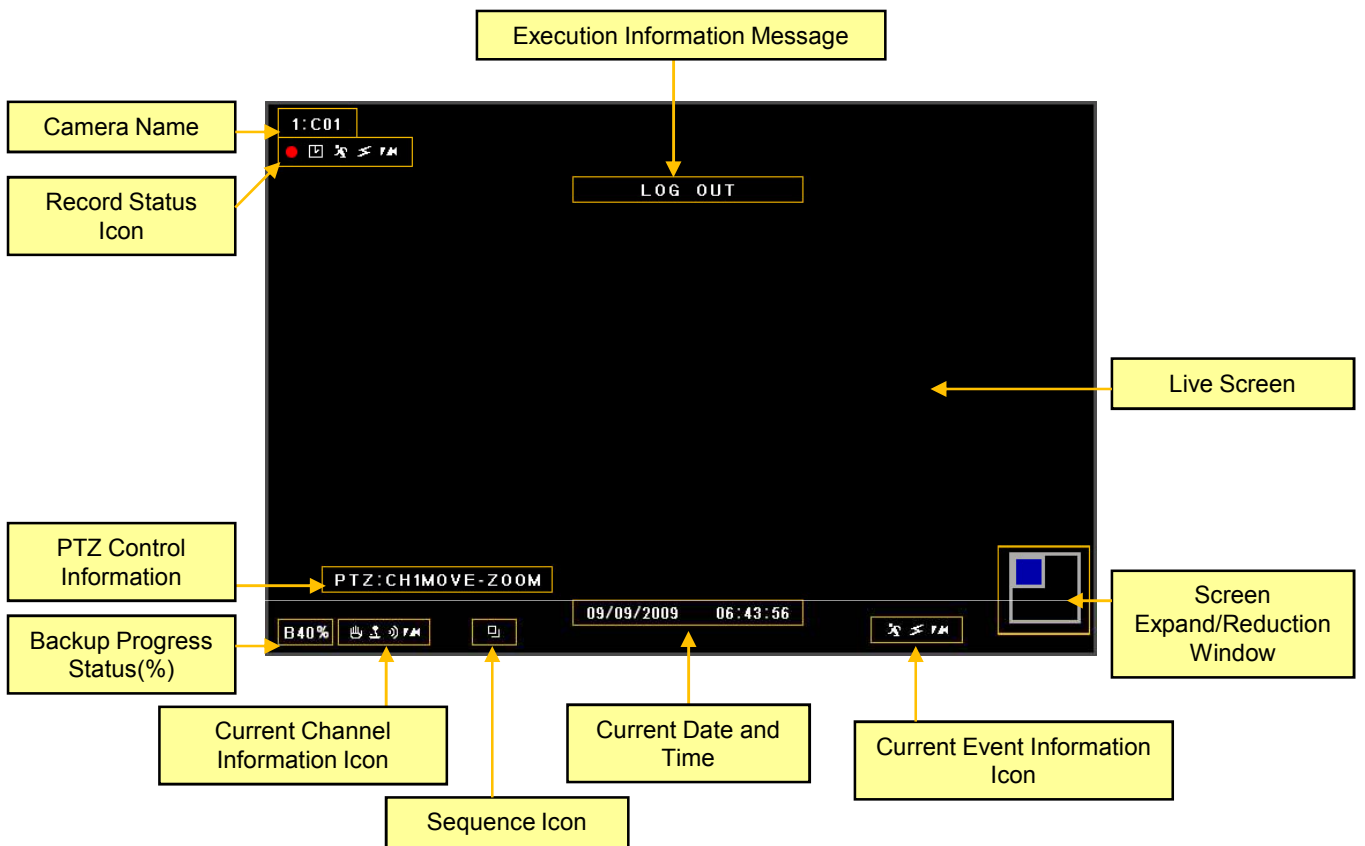

- Record Icon (Red)
When record in live screen.



- Time Icon
When record by designated time.



- Motion Icon
When motion is occurred.



- Sensor Icon
When sensor is occurred.



- Video-loss Icon
When there is no video input.



- Audio Icon
When sound is generated in live mode.



- Freeze Icon
When live is paused.



- Sequence Icon
When screen is rotated continuously.

4.1.1 Top Menu

In live screen, if ▲ button of the remote controller or front panel is pressed, or if the mouse cursor is placed over the end of the top area, the top menu is appeared.



4.1.2 Bottom Menu

In Live screen, if ▼ button of the remote controller or front panel is pressed, or if the mouse cursor is placed over the end of the bottom area, the bottom menu is appeared.

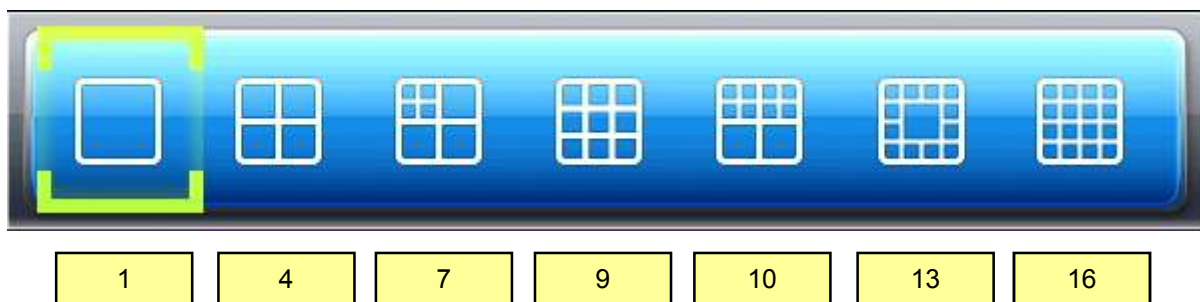

4.1.3 CAMEO Menu

In live screen, if the ENTER button of the remote controller or front panel is pressed, a blue square cursor will be appeared. If the ENTER button is pressed again, the CAMERA menu will be appeared.



- **CAMEO CHANGE** : The live camera can be changed to the selected channel.
If the camera number is selected at the pop-up menu shown below, the camera is changed to the selected channel.

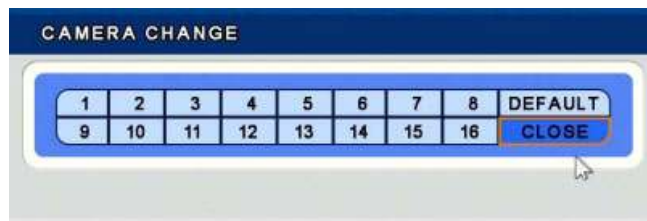

- **FREEZE** : Live screen of the selected channel can be paused.
- **FREEZE ALL** : Live screen of the all channels can be paused.
- **SEQUENCE** : Live screen is rotated.

- **PTZ** : PTZ Camera should be installed otherwise the PTZ menu is not activated.

The following picture will be appeared when select PTZ menu.



- ※ **Using Mouse** : On the above menu, when click the right button of mouse, the control screen for Menu, Zoom, Focus and Iris will be appeared.

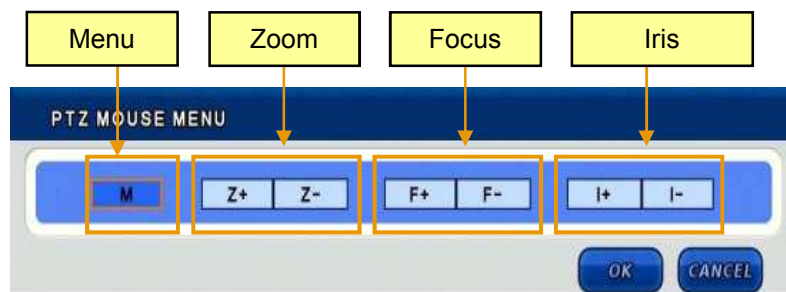

- ※ **Using Remote Controller or Front Key** : The below Hot Key is available.

- Press the ENTER button on PTZ Camera channel.
- Press the ENTER button again then the CAMEO menu will be appeared.
- Select PTZ menu on the Live CAMEO menu.
- Press the ENTER button again, the above PTZ menu screen will be appeared.
- **Zoom Control** : In PTZ mode, press the Zoom (Back) button.
Zoom in - Fast reverse play button / Zoom out - The fast forward play button.
- **Focus Control** : In PTZ mode, press the Focus (Search) button.
(+) - Fast reverse play button / (-) – Fast forward play button.
- **Iris Control** : In PTZ mode, press the Iris (Pause) button.
(+) – Fast reverse play button / (-) – Fast forward play button.



- **SPEED SETUP** : Set the PTZ camera speed. (1 to 8)

NOTE: If the mouse is used to move the PTZ camera, the movement speed depends on the position of the mouse. As the mouse pointer moves away from the center, speed becomes faster.

- **PRESET SETUP** :

Set the preset position. If the position setup is saved, PTZ camera will be directed to the set position by preset number.

- **PRESET TOUR** :

6 different preset list can be created. If the created preset lists are set to "ON", recording is made with preset tour.

- **PATTERN SETUP** :

Pattern can be created by movement, zoom, focus and iris. After pressing the BEGIN button, adjust the PTZ camera position or zoom and then press the END button. All directions (up, down, left and right), zoom and iris settings are recorded.

- **PATTERN TOUR** : PTZ camera moves according to the saved pattern.

- **AUTO FOCUS / POWER / LIGHT** :

Auto focus, power and light functions can be turned on/off on each category.

- **OSD MENU** : Turn on/off the OSD menu.

▪ **ZOOM X2** : Zoom in x2.

▪ **ZOOM X4** : Zoom in x4.

▪ **ADUIO ON** : Turn on/off Audio.

5. SETUP

In this category, there are *SYSTEM, NETWORK, DEVICE, RECORD* and *EVENT*.

On the Top menu, select the [SETUP] menu icon.



After select the icon, the following LOGIN window will be appeared.

A login window titled 'LOGIN'. It has two input fields: 'ID' containing 'admin' and 'PASSWORD'. Below the password field is a numeric keypad with buttons for digits 0-9 and a left arrow. At the bottom are 'OK' and 'CANCEL' buttons.

ID		admin			
PASSWORD					
0	1	2	3	4	←
5	6	7	8	9	

Enter the password by the key buttons and press the OK button.

(The default password : 1)

5.1 SYSTEM SETUP

In this category, there are *General, Alarm, Disk, Monitor, Account, Configuration* and *Shutdown*.

Select the [SYSTEM] menu.



5.1.1 GENERAL

GENERAL SETUP - SYSTEM		
GENERAL	SYSTEM	DATE / TIME
ALARM OUT	VIDEO FORMAT	NTSC AUTO
DISK	LANGUAGE	ENGLISH (ENGLISH)
MONITOR	KEY TONE	OFF
ACCOUNT	UNIT ADDRESS	0
CONFIG	BASE CAMERA NO.	1
SHUTDOWN	MENU TIME OUT	OFF
	RECORD RETENTION	OFF
	BACKUP CONFIRM	OFF
	HDD OVERWRITE	ON
	DEINTERLACE	OFF

[SYSTEM]

- **VIDEO FORMAT** : Set the Camera Type (NTSC / PAL)
If select AUTO menu, DVR recognize camera type automatically.

NOTE: If NTSC and PAL cameras are connected simultaneously, error may occur.
- **LANGUAGE** : Select the language.
(English, Germany, French, Spanish, Japanese, Chinese, Italian, Russian, Dutch and Korean)
- **KEY TONE** : Turn on/off the buzzer sound of key.
- **UNIT ADDRESS** : Set the DVR ID.
This ID can be used when use multi DVR in same place by one remote controller.
- **BASE CAMERA NO.** : Set the beginning number of camera.
If set this value to 17, the camera number start with 17.
- **MENU TIMEOUT** : Keep the Menu screen for this value then escape from Menu.
- **RECORD RETENTION** : Prohibit the playback of passed data.
(Select 0 to 99 days. If set 3 days, can not playback the data that elapsed 3 days.)
- **BACKUP CONFIRM** : Confirm the backup process.(Log-in process)
- **HDD OVERWRITE** : Select on/off to overwrite data on Hard disk.
NOTE: If set to [OFF], recording will be stopped automatically when disk is full.
- **DEINTERLACE**: This is playback quality option if the resolution is set D1.
[OFF] : Played by original.
[ON] : Played by Deinterlace.

5.1.1 GENERAL

GENERAL SETUP - DATE / TIME		
GENERAL	SYSTEM	
ALARM OUT	DATE / TIME	
DISK	DATE FORMAT	YYYY / MM / DD
MONITOR	TIMEZONE	GMT+09:00.. DST OFF
ACCOUNT	DATE DISPLAY	ON
CONFIG	DATE / TIME	2011/12/13 16:49:44
SHUTDOWN	NTP	ON
	HOLIDAY	0 DAYS ▶

[DATE / TIME]

- **DATE FROMAT** : Select the data format.
(YY/MM/DD) / (MM/DD/YY) / (DD/MM/YY)
- **TIMEZONE** : Select the timezone and DST.
The city which don't use DST is set to [OFF] automatically.
- **DATE DISPLAY** : Display date on live screen or not.
- **DATE / TIME** : Change date and time.
- **NTP** : Select the usage of NTP setting.
DVR time is synchronized with NTP server and get the standard time.
The default server is [pool.ntp.org] and User can input other server.

[Sync now] : Synchronize immediately.
[Auto Sync] : Synchronize every day automatically.
- **HOLIDAY** : Add or delete holiday.

5.1.2 ALARM OUT

ALARM OUT	SIGNAL +
1	ON
2	ON
3	ON
4	ON

ALARM SET TEST	SET
ALARM CLEAR TEST	CLEAR

- **SIGNAL** : Select on/off to use alarm by channel.
- **ALARM SET TEST** : Check the alarm connection whether it works properly or not. Press the [SET] button then alarm device will be operated.
- **ALARM CLEAR TEST** : Press the [CLEAR] button then alarm device will not be operated.

5.1.3 DISK

RECORD START TIME	2011/11/29 04:00:00
RECORD END TIME	2011/12/13 16:00:54
DISK CHECK	START

USB RESET	SET
USB FORMAT	SET

※ **NOTE :**
When install HDD first time, after install HDD, should format by the [INSTALL] button.

[INSTALL] - Display initial HDD install and information.

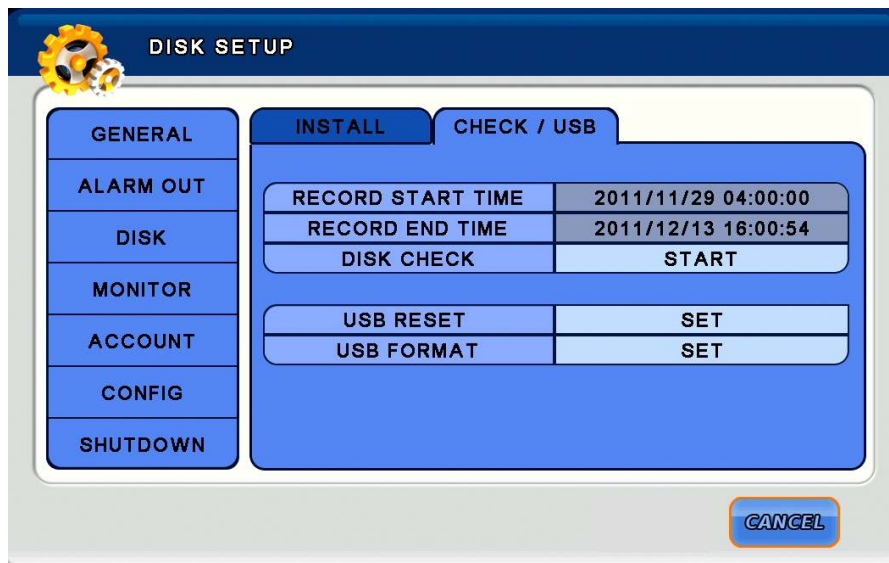

[CHECK / USB]

- **EARLIEST RECORD** : Display the earliest recorded data information.
- **LATEST RECORD** : Display the latest recorded data information.
- **DISK CHECK** : Check the data from the earliest recorded to the latest recorded.
- **MOUSE RESET** : Reset the mouse connection.
- **USB RESET** : Reset the USB connection.
- **USB FORMAT** : Format the connected USB.

5.1.4 MONITOR



- **RESOLUTION** : Select the resolution for connected monitor.
- **MAIN OUT** : Select main monitor. (CCTV / LCD)
(Fix the screen by connected monitor)
- **BORDER COLOR** : Change the border color.
- **ALPHA BLENDING** : Set the transparency of menu.
(Set 1 to 20 and 20 is closer to the more transparent.)

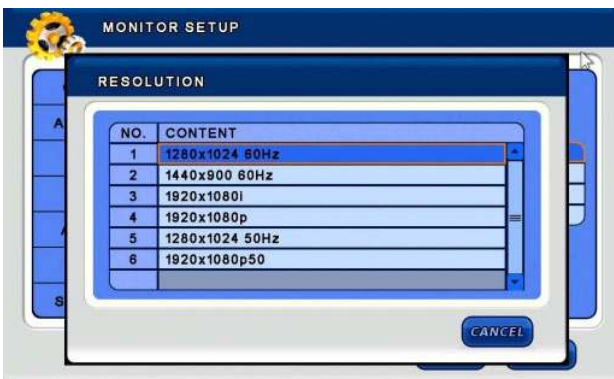

[RESOLUTION selected screen]

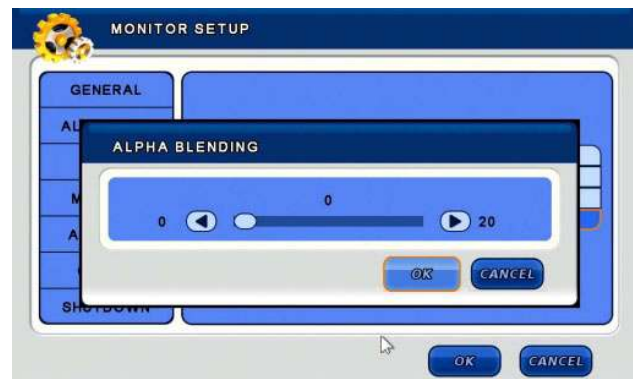

[ALPHA BLENDING selected screen]

5.1.5 ACCOUNT

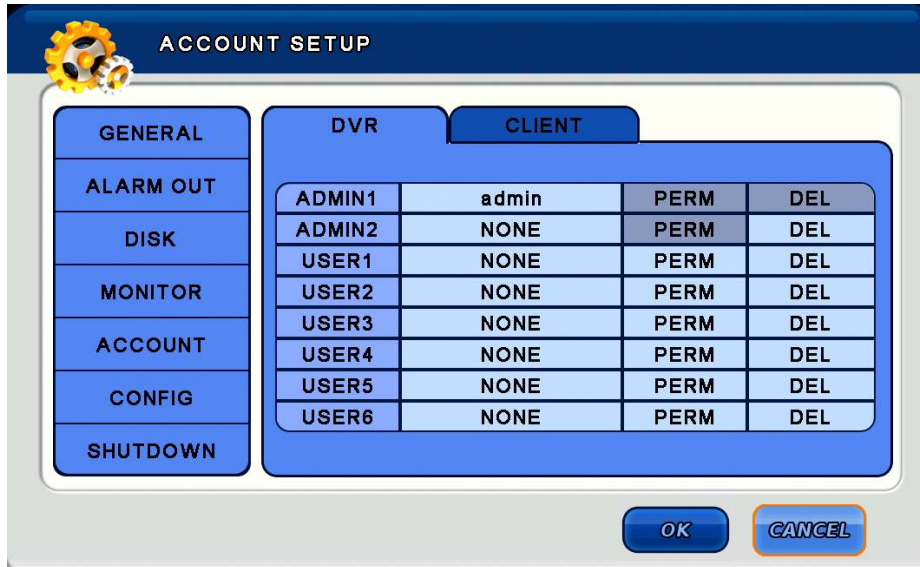

- ※ Add / delete any user and give permission freely.
- ※ When add new user, have to input new password.
When delete user, confirm again.

NOTE: (Default ADMIN password is 1), Initial user name can be modified but can not delete.

CAUTION:

Default Admin account must not be deleted before add new user.

If delete default Admin user before add new Admin user, can not access on [SETUP] menu.

- ※ By the [PERM] menu, can give permission to each ID.

5.1.6 CONFIG

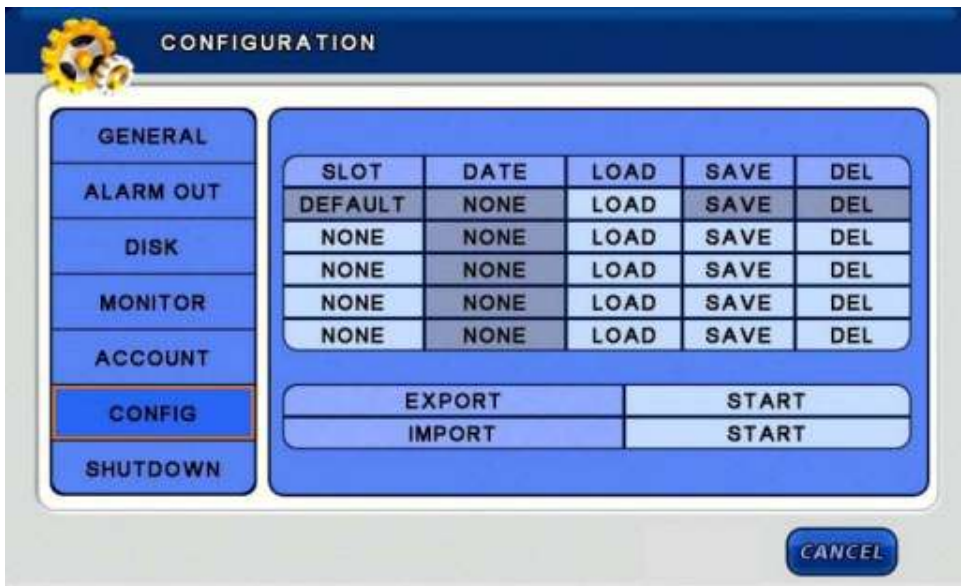

- **SLOT** : Select the slot to load or save on DVR memory.
 - ※ DEFAULT : Change factory default setting.
- **DATE** : Display the latest saved date.
- **LOAD** : Load the saved data.
- **SAVE** : Save the set data.
- **DEL** : Delete the saved data on Slot.
- **EXPORT** : Export the set data to USB or DVD.
- **IMPORT** : Import the set data to USB or DVD.



[DEFAULT selected screen]

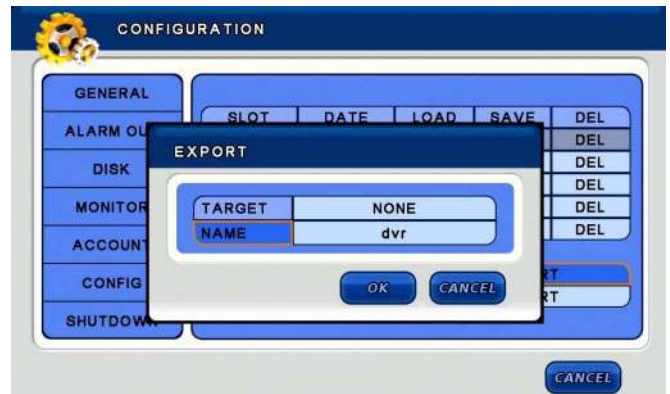

[EXPORT selected screen]

5.1.7 SHUTDOWN



- **RESTART** : Restart the DVR.
- **SHUTDOWN** : Shutdown the DVR.

5.2 DEVICE SETUP

In this category, there are Camera, PTZ, Spot, Sequence and Private Zone setting.

Select the [DEVICE] Menu.



5.2.1 CAMERA

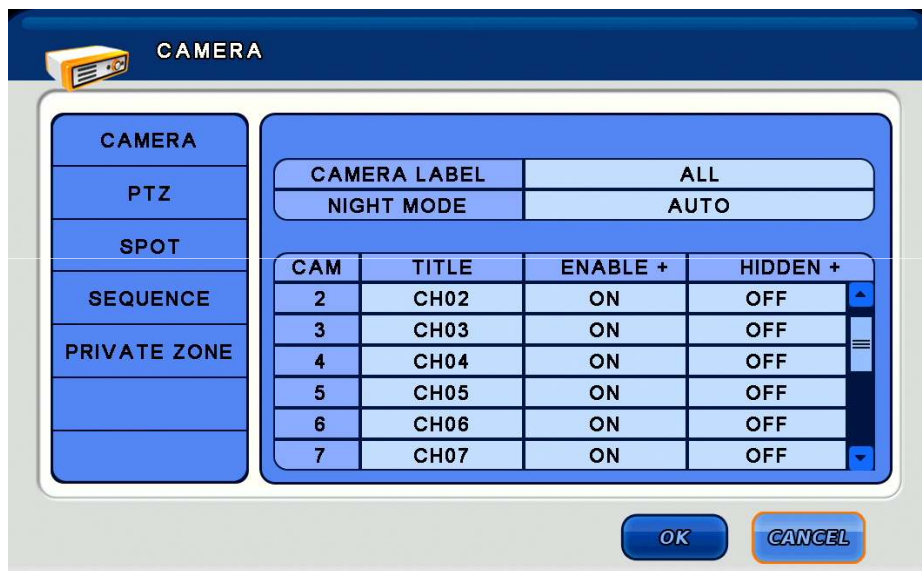

- **CAMERA LABEL** : Select the camera label of live screen.
(ALL / NUMBER / NAME / OFF)
- **NAME** : Change the camera name. (If select the camera name, the virtual keyboard will be appeared.)
- **INSTALL** : Select On/Off button to use camera.
- **HIDDEN** : Select On/Off button to hide camera on live view. (Record works correctly.)

NOTE: If select [INSTALL] – [OFF], Camera name and number are not displayed.



If select the camera name,
the virtual keyboard will be appeared.
Max camera name should be less than
11 character.

[Virtual Keyboard]

5.2.2 PTZ



[PTZ]

- **PORT** : Select the Baud Rate for using PTZ camera.
- **ADDRESS** : Select the ID for using PTZ camera.
- **PROTOCOL** : Show the PTZ protocol list.

NOTE : baud rate, data bit, parity, stop bit, ID and protocol depend on PTZ camera for using.

CAUTION : When connect the camera on the RS-485 port, refer to the manual of camera manufacturer.

5.2.3 SPOT

SPOT SETUP

	SPOT 1	SPOT 2	SPOT 3
CAMERA	ON	ON	ON
DEFAULT	2	1	1
SPLIT	1	1	1
SEQUENCE	OFF	OFF	OFF
INTERVAL	2 SEC	2 SEC	2 SEC
POPUP	OFF	OFF	OFF

OK CANCEL

CAMERA : Select the camera for display on spot monitor.

DEFAULT : Select the camera for display on spot monitor when sequence is off.

SEQUENCE : Select On/Off for sequence screen.

INTERVAL : Select the interval time to move next channel. The max value is 256 sec.

POPUP : Select On/Off for pop-up screen when event is occurred.

SPOT SETUP

CAMERA

SPOT : 1

ALL

1 2 3 4 5 6 7 8

9 10 11 12 13 14 15 16

OK CANCEL

[CAMERA selection screen]

SPOT SETUP

CAMERA

SE

PRIV

INTERVAL : 1 - SEC

1 2 256

OK CANCEL

[INTERVAL selection screen]

5.2.4 SEQUENCE

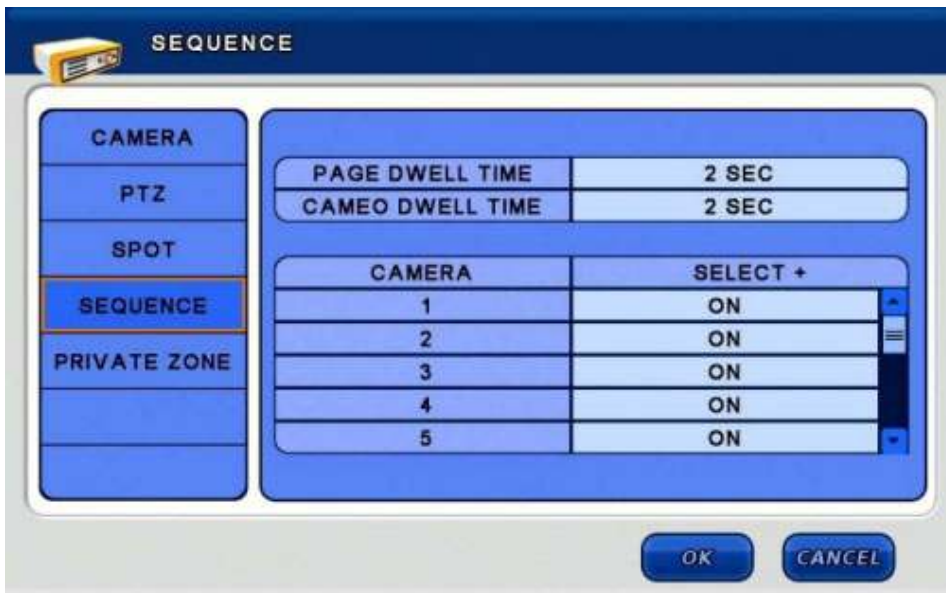

PAGE DWELL TIME : Select the dwell time to move next channel.

CAMEO DWELL TIME : Select the dwell time for CAMEO sequence.

NOTE: CAMEO sequence means selected camera is rotated in select cameo of division screen.

Camera image which is shown on the other CAMEO of division screen is not included in CAMEO sequence.



[DWELL-TIME selected screen]

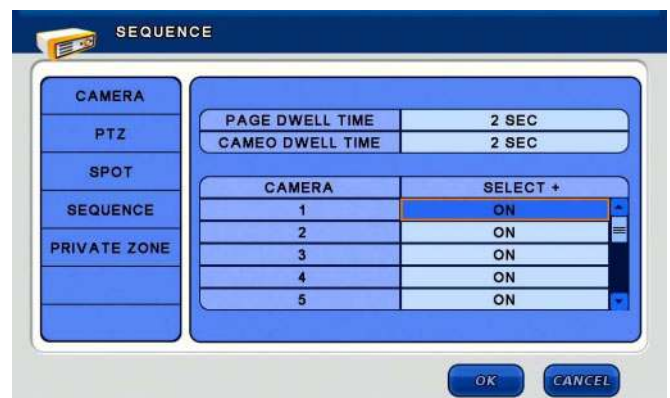

[CAMERA SELECT screen]

5.2.5 PRIVATE ZONE



- **ZONE ENABLE** : Select On/Off to use. (LIVE mode/ SEARCH mode)
- **ZONE COLOR** : Select the color to hide.
- **ZONE** : Select the zone to hide.
(When select the ZONE button, the camera image will be appeared.)

NOTE : Move the blue dot to a desired location and press the OK button.
 Drag and move it to include the desired area and press the OK button.
 As a result, the area is covered and hidden with the selected color

TIP : On the screen, if click the right button of mouse, a menu will be appeared.
 Using this menu, a selected area can be delete or saved, or returned previous menu.

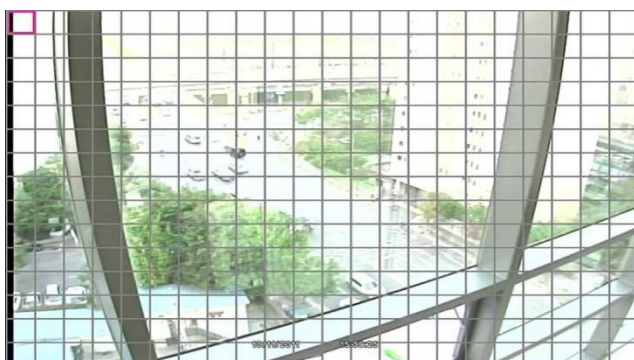

[ZONE selected screen]



[Mouse right button selected screen]

5.3 EVENT SETUP

In this menu, there are Motion, Alarm in, Video Loss, System and Display setup.

Select the [EVENT] menu.



5.3.1 MOTION



[INPUT]

- **ACTIVE** : Select On/Off to activate motion.
- **LEVEL** : Select the sensitive for motion trigger. (Select 1 to 5 level)
- **AREA** : Select the motion area.

TIP: If select the ACTIVE+ / LEVEL+ / AREA+ menu, can change all setting at once.

▪ AREA SETUP

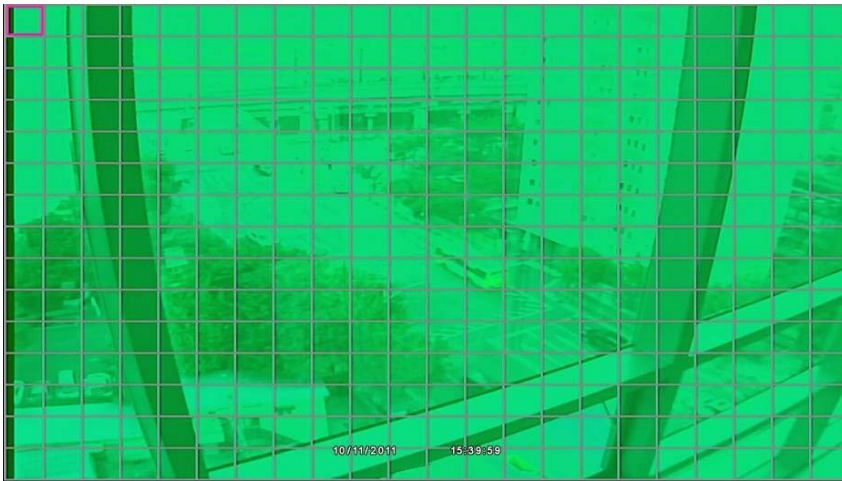

In the Area setup, the Red square is shown at the top left side of the screen. If select the OK button, the dot color will be changed to Green. A motion area can be selected by the direction buttons.

NOTE : When the status is Red square, can move any direction to select.
When the status is Green color, can select motion area or cancel the set area.

After set the motion area, if select the MENU button, the following screen will be appeared.



- **SELECT ALL** : Select all motion area.
- **CLEAR ALL** : Clear all motion area.
- **SAVE** : Save the changed setting.
- **CLOSE** : Close the pop-up screen.
- **EXIT** : Exit the motion area setup.



[ACTION]

- **RECORD** : Select the channel for record.
- **ALARM** : Select On/Off for alarm.
- **BUZZER** : Select On/Off for buzzer.
- **PRESET** : Set the preset number.
 (When motion is triggered, the PTZ camera move to the set preset number position)
- **E-MAIL** : Select On/Off for e-mail notification.

TIP: If select to the [DEFAULT], only record the channel which is occurred event.

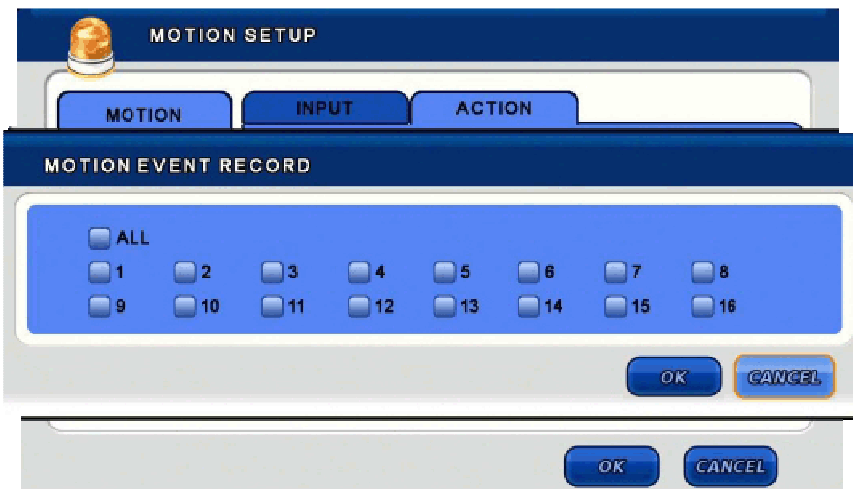

5.3.2 ALARM IN

NO.	ACTIVE +	NAME	TYPE +
1	OFF	s01	NO
2	OFF	s02	NO
3	OFF	s03	NO
4	OFF	s04	NO
5	OFF	s05	NO
6	OFF	s06	NO
7	OFF	s07	NO

TIP:

If select the ACTIVE+ / TYPE+ menu, can change all setting at once.

[INPUT]

- **ACTIVE** : Select On/Off to activate alarm.
- **NAME** : Type any name.
- **TYPE** : Select the alarm type. (NO : Normal Open / NC : Normal Close)

NO.	RECORD	ALARM	BUZZER	PRESET	E-MAIL
1	OFF	OFF	OFF	1	OFF
2	OFF	OFF	OFF	1	OFF
3	OFF	OFF	OFF	1	OFF
4	OFF	OFF	OFF	1	OFF
5	OFF	OFF	OFF	1	OFF
6	OFF	OFF	OFF	1	OFF
7	OFF	OFF	OFF	1	OFF

[ACTION]

- **RECORD** : Select the channel for record.
- **ALARM** : Select On/Off for alarm.
- **BUZZER** : Select On/Off for buzzer.
- **PRESET** : Set the preset number.
(When motion is triggered, the PTZ camera move to the set preset number position)
- **E-MAIL** : Select On/Off for e-mail notification.

5.3.3 VIDEO LOSS



TIP:

If select the ACTIVE+ menu, can change all setting at once.

[INPUT]

- **ACTIVE** : Select On/Off to activate.

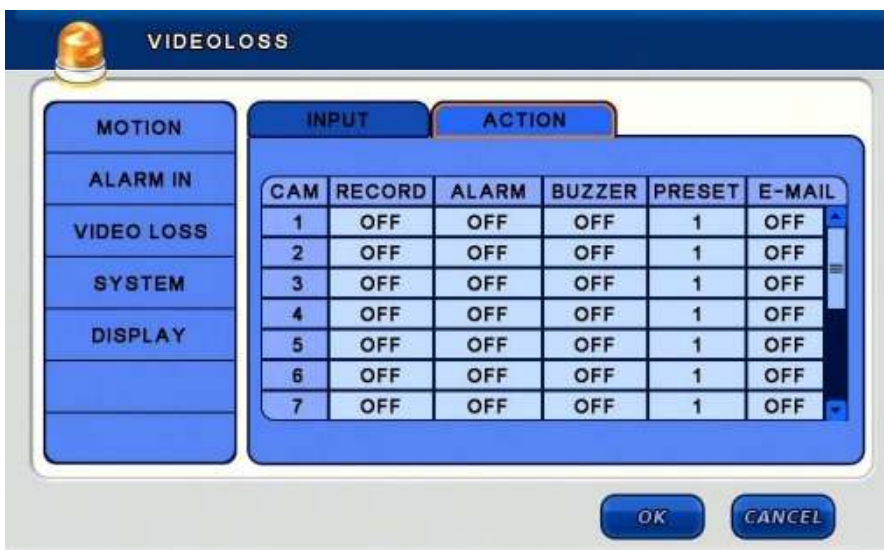

[ACTION]

- **RECORD** : Select On/Off for record.
- **ALARM** : Select On/Off for alarm.
- **BUZZER** : Select On/Off for buzzer.
- **PRESET** : Set the preset number.
(When motion is triggered, the PTZ camera move to the set preset number position)
- **E-MAIL** : Select On/Off for e-mail notification.

5.3.4 SYSTEM

The screenshot shows a 'SYSTEM SETUP' window with a blue header and a yellow warning light icon. On the left is a vertical menu with options: MOTION, ALARM IN, VIDEO LOSS, SYSTEM (highlighted), and DISPLAY. The main area has three tabs: WARNING (selected), DISK, and E-MAIL. The WARNING tab contains several settings:

CHECK INTERVAL	1 HOUR	
DISK WARNING	POPUP	
THRESHOLD	54	C
CURRENT TEMP.	36 C	
FAN SPEED WARNING	OFF	
THRESHOLD	1500 RPM	
CURRENT SPEED	-	

At the bottom right are 'OK' and 'CANCEL' buttons.

[WARNING]

- **CHECK INTERVAL** : Select the check interval. (Select 1 hour to 24 hour)
- **DISK WARNING** : Select how to give a warning if disk error. (OFF, POPUP, POPUP + BUZZER)
- **THRESHOLD** : Critical value for Warning
- **CURRENT TEMP.** : Current temperature of the system
- **FAN SPEED WARNING** :
Select warning ON/OFF, then how to warn at less than critical value. (OFF, POPUP + BUZZER, POPUP)
- **THRESHOLD** : Critical value for Warning
- **CURRENT SPEED** : Current speed of the fan

[DISK]

- **DISK FULL WARNING** : Select ON/OFF to disk full warning.
- **USED SPACE** : Display the used space
- **ALARM** : Select the channel for alarm out.
- **BUZZER** : Select On/Off for buzzer.
- **MESSAGE** : Select On/Off for message.



[E-MAIL] – Select option On/Off for e-mail notification.

- POWER / MENU / LOGIN FAIL / DISK FULL / LOG IN / SMART

5.3.5 DISPLAY



- **DISPLAY** : Select display time by second. (Select 0 to 100)
- **EVENT MESSAGE** : Select On/Off to display event message.
- **EVENT POPUP** : Select On/Off to pop-up.

5.4 RECORD SETUP

In this menu, there are Resolution, Schedule, Record, Audio, Manual, Filter setup.

Select the [RECORD] menu.



5.4.1 RESOLUTION

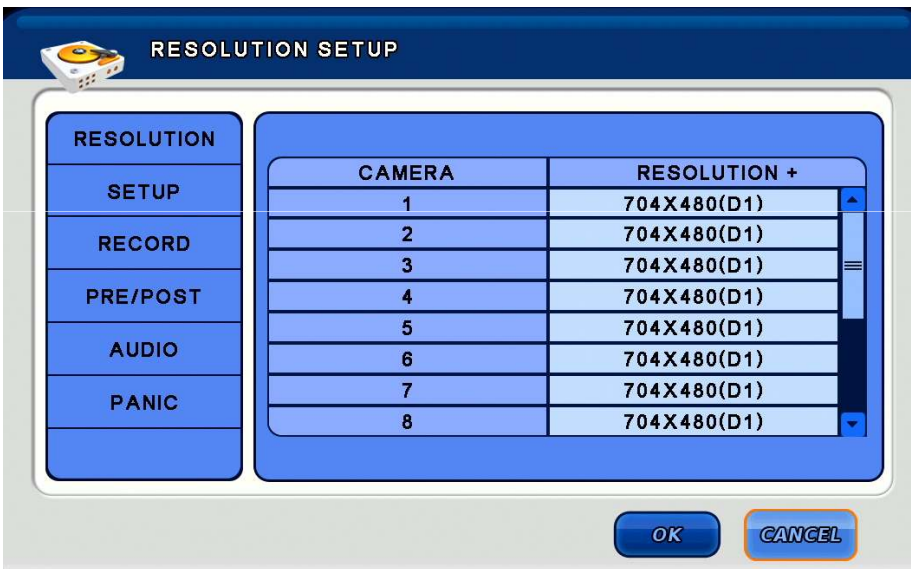

- **RESOLUTION** : Select the resolution by each channel.
(HIGHEST=D1 / HIGH=Half D1 / STD=CIF)

5.4.2 SCHEDULE & RECORD

SCHEDULE SETUP

RESOLUTION
SETUP
 RECORD
 PRE/POST
 AUDIO
 PANIC

RECORD MODE CONTINUOUS

	FROM	TO
DAY TIME	00:00:00	00:00:00
WEEKEND	OFF	OFF

OK CANCEL

- **SETUP MODE** : Select the record schedule. (CONTINUOUS / SCHEDULE)

[CONTINUOUS]

- **DAY TIME** : Select the day time. (The night time is changed automatically according to the day time zone)
- **WEEKEND** : Set the weekend zone.

RECORD SETUP

RESOLUTION
 SETUP
RECORD
 PRE/POST
 AUDIO
 PANIC

DAY NIGHT WEEKEND

CAMERA	NORMAL +	EVENT +
1	30, HIGHEST	15, HIGHEST
2	30, HIGHEST	15, HIGHEST
3	30, HIGHEST	15, HIGHEST
4	30, HIGHEST	15, HIGHEST
5	30, HIGHEST	15, HIGHEST
6	30, HIGHEST	15, HIGHEST
7	30, HIGHEST	15, HIGHEST

OK CANCEL

[DAY] / [NIGHT] / [WEEKEND]

- **TIME** : Set the recording frame and resolution by channel.
- **EVENT** : Set the event recording. (Frame / Resolution / Post recording time [5 to 100 second])

[CUSTOM]

- Set 3 different recording setup by day and time. (REC1, REC2, REC3)

This is related with [RECORD] menu so [CUSTOM] mode should be matched with [RECORD] menu.

TIP : For REC1, REC2, REC3 recording, change the setting [SETUP MODE] to [TYPICAL] and enter to the [RECORD] menu then change the setting.

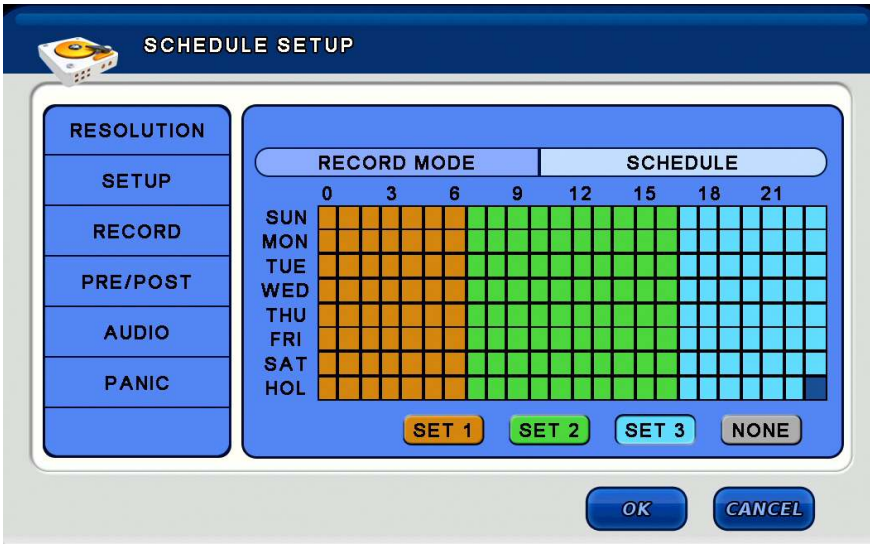

[SCHEDULE selected screen]

If set to [CONTINUOUS] in [SCHEDULE] menu, the DAY / NIGHT / WEEKEND menu will be changed to SET1/ SET2 / SET3. Also set the frame and resolution.



[RECORD] screen after select [SCHEDULE] menu

TIP : The frame can be set by the direction button in setup screen.

5.4.3 AUDIO



- **RECORD** : Select On/Off for audio recording by channel.

***TIP:** If select the RECORD+ menu, can change all setting at once.*

5.4.4 PANIC

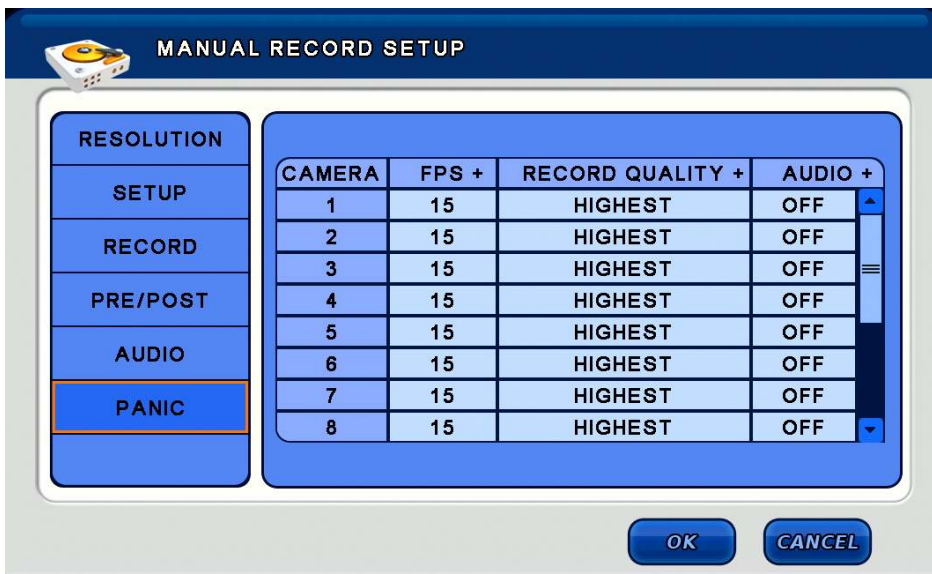

- **FPS** : Select the recording frame by each channel.
- **Quality** : Select the resolution by each channel.
- **AUDIO** : Select On/Off for audio recording by each channel.

5.5 NETWORK SETUP

In this menu, there are Network, Serial, DDNS, E-mail setup.

Select the [NETWORK] menu.



5.5.1 NETWORK

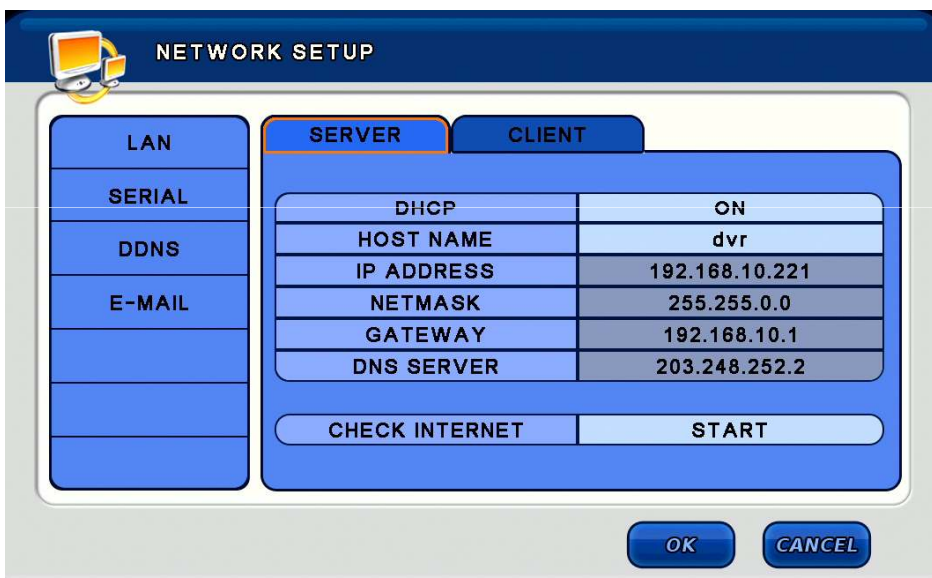

SERVER		CLIENT	
DHCP		ON	
HOST NAME		dvr	
IP ADDRESS		192.168.10.221	
NETMASK		255.255.0.0	
GATEWAY		192.168.10.1	
DNS SERVER		203.248.252.2	
CHECK INTERNET		START	

[SERVER]

- **DHCP** : Select On/Off for dynamic IP.

If Dynamic IP is OFF, DVR get IP address from router automatically.

- **HOST NAME** : Type any Host name.
- **IP ADDRESS** : Type IP address. (Available when DYNAMIC IP is OFF)
- **SUBNET MASK** : Type Subnet mask. (Available when DYNAMIC IP is OFF)
- **GATEWAY** : Type Gateway. (Available when DYNAMIC IP is OFF)
- **DNS SERVER** : Type DNS server. (Available when DYNAMIC IP is OFF)
- **CHECK INTERNET** : Check internet status for use.

NETWORK SETUP

LAN
SERIAL
DDNS
E-MAIL

SERVER **CLIENT**

CLIENT ACCESS	ALL
BEGIN ADDRESS	END ADDRESS
0.0.0.0	0.0.0.0
0.0.0.0	0.0.0.0
0.0.0.0	0.0.0.0

XMS PORT (TCP)	9013
WEB PORT (TCP)	80
REMOTE RESTART	OFF
REMOTE CONFIG	ON

OK CANCEL

[CLIENT]

- **CLIENT ACCESS** : Select client access options. (ALL / RANGE)
- **BEGIN ADDRESS / END ADDRESS** (When select RANGE option, type the IP address to accept)
: Input the acceptable IP address.
- **SMS PORT (TCP)** : Select SMS port.
- **WEB PORT (TCP)** : Select Web port.
- **REMOTE RESTART** : Select On/Off to restart DVR at remote.
- **REMOTE CONFIG** : Select On/Off to change configuration.

5.5.2 SERIAL

RS-232 INPUT SETUP	
SERIAL TYPE	NONE
MODEL	NONE
PORT	9600-8N1

RS-485 INPUT SETUP	
SERIAL TYPE	NONE
MODEL	NONE
PORT	9600-8N1

[RS-232 INPUT SETUP]

- **SERIAL TYPE** : Select external device.
- **MODEL** : Select the protocol to use.
- **PORT** : Select the Baud Rate / DATA bit / Parity / Stop Bit.

[RS-485 INPUT SETUP]

- **SERIAL TYPE** : Select external device.
- **MODEL** : Select the protocol to use.
- **PORT** : Select the Baud Rate / DATA bit / Parity / Stop Bit.

5.5.3 DDNS

DDNS SETUP	
NETWORK	
SERIAL	
DDNS	
E-MAIL	
DDNS SERVER	NONE
HOST NAME	
USER NAME	
PASSWORD	****
ROUTER IP	OFF
STATUS	<input type="checkbox"/> UNCHECKED <input type="checkbox"/> CHECK

OK CANCEL

- **DDNS SERVER** : Select DDNS server. (ezddns.com / dyndns.com)
- **HOST NAME** : Input the host name from the registered on DDNS server.
- **USER NAME** : Input the user name from the registered on DDNS server.
- **PASSWORD** : Input the password from the registered on DDNS server.
- **ROUTER IP** : Select On/Off for sending IP information to the DDNS server.
If use any router, this setting should be [ON].
- **STATUS** : Check the connection status.

NOTE : For using DDNS server, firstly connect the DDNS server and register Host name, User name password then input those information on above menu.

5.5.4 E-MAIL

The screenshot shows the 'E-MAIL SETUP' dialog box with the 'ADDRESS' tab selected. On the left is a navigation pane with 'E-MAIL' highlighted. The main area contains a table for mail settings and a list of email addresses.

ADDRESS		SERVER	
SEND MAIL	SCHEDULE	FROM	TO
ON	ON	00:00:00	23:59:59

NO.	E-MAIL ADDRESS
1	user1@dvr.com
2	user2@dvr.com
3	user3@dvr.com
4	user4@dvr.com
5	
6	

Buttons: OK, CANCEL

[ADDRESS]

- **SEND E-MAIL** : Select On/Off for use.
- **SCHEDULE** : Set the usage time. (From : Start time / To : End time)
- **E-MAIL ADDRESS** : Input the E-mail address to receive.

The screenshot shows the 'E-MAIL SETUP' dialog box with the 'SERVER' tab selected. The main area contains a table for server configuration.

SERVER	
MAIL SERVER	SMTP SERVER
USER NAME	UserName
USER E-MAIL	email@ddnsdvr.com
SERVER ADDRESS	ddnsdvr.com
SERVER PORT	25
LOGIN ID	UserId
LOGIN PASSWOR	****

Buttons: OK, CANCEL

[SERVER]

- **MAIL SERVER** : Select the mail server. (SMTP server / DVR System)
- **USER NAME** : Input the user name.
- **USER E-MAIL** : Input the user e-mail address.
- **SERVER ADDRESS** : Input the server address.
- **SERVER PORT** : Input the server port.
- **LOGIN ID** : Input the Login ID.
- **LOGIN PASSWORD** : Input the Login password.

5.6 SYSTEM INFORMATION

In this menu, there are System Log, Status, Version.

On the Top menu, select the [INFORMATION] menu icon.

5.6.1 SYSTEM LOG

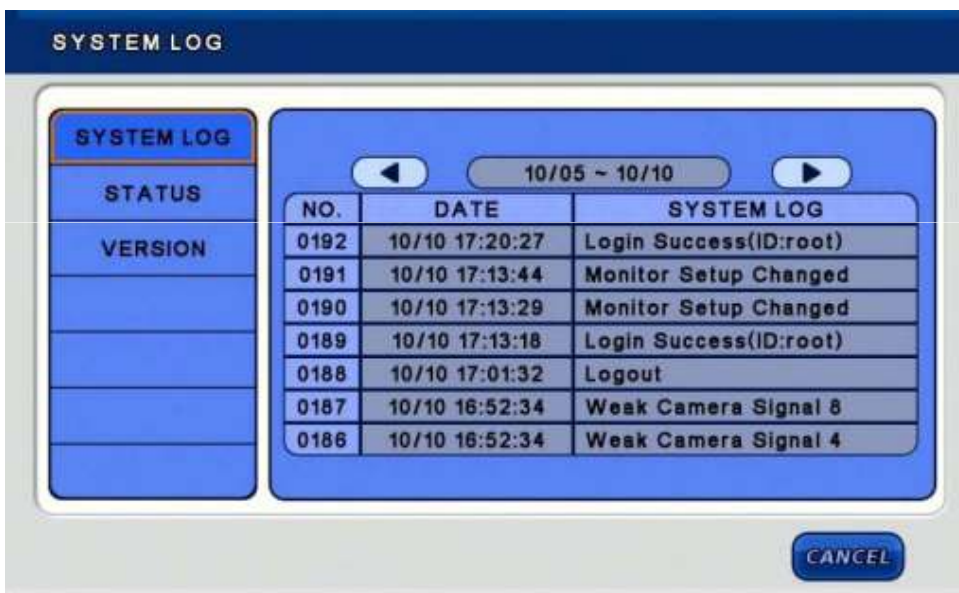

- Check the system log by the left, right direction button.

5.6.2 STATUS

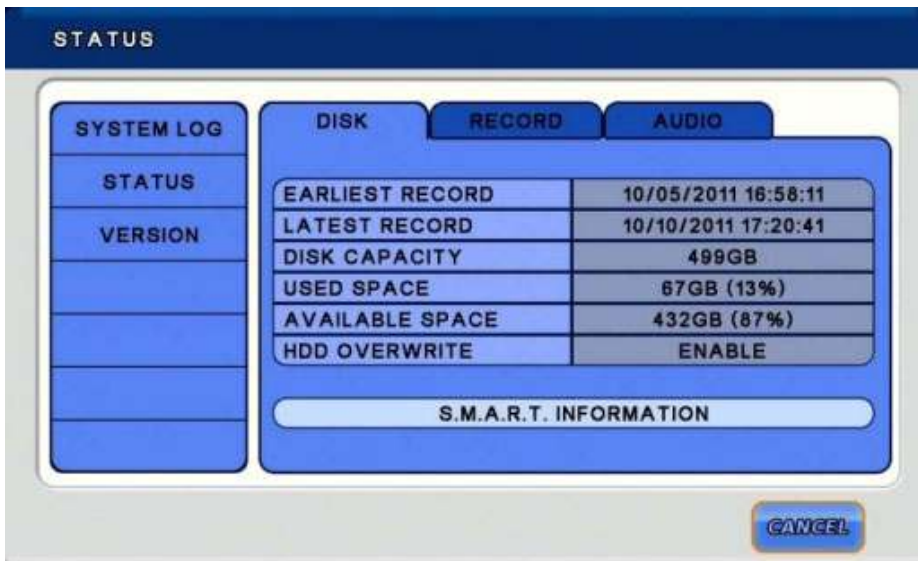

[DISK]

- Display HDD Status.
- **CHECK SMART NOW** : Check the smart.
- **SMART INFORMATION** : Show the smart information.

[RECORD]

- Display RECORD Status.



[AUDIO]

- Display AUDIO Status.

5.6.3 VERSION



- Display DVR version and information.



6. SEARCH



After select the menu, the following Log-in window will be appeared.

A window titled 'LOGIN' with a dark blue header. It contains two input fields: 'ID' with the text 'admin' and 'PASSWORD'. Below the password field is a numeric keypad with buttons for digits 0-9 and a left arrow button. At the bottom are 'OK' and 'CANCEL' buttons. The left arrow button is highlighted with an orange border.

Enter the password by the key buttons and press the ENTER button.

(The default password : 1)

A window titled 'SEARCH' with a dark blue header. It contains a list of search options: 'QUICK SEARCH', 'CALENDAR', 'EVENT SEARCH', 'OVERLAPPED LIST', 'GO TO FIRST', and 'GO TO LAST'. At the bottom is a 'CANCEL' button.

- **QUICK SEARCH** : Designated time search by User
- **CALENDAR** : Search by date and time with Calendar.
- **EVENT SEARCH** : Search by event
- **OVERLAPPED LIST** : Search the overlapped data by changing time
- **GO TO FIRST** : Search with initial saved data.
- **GO TO LAST** : Search with the latest saved data.

6.1 Search Screen

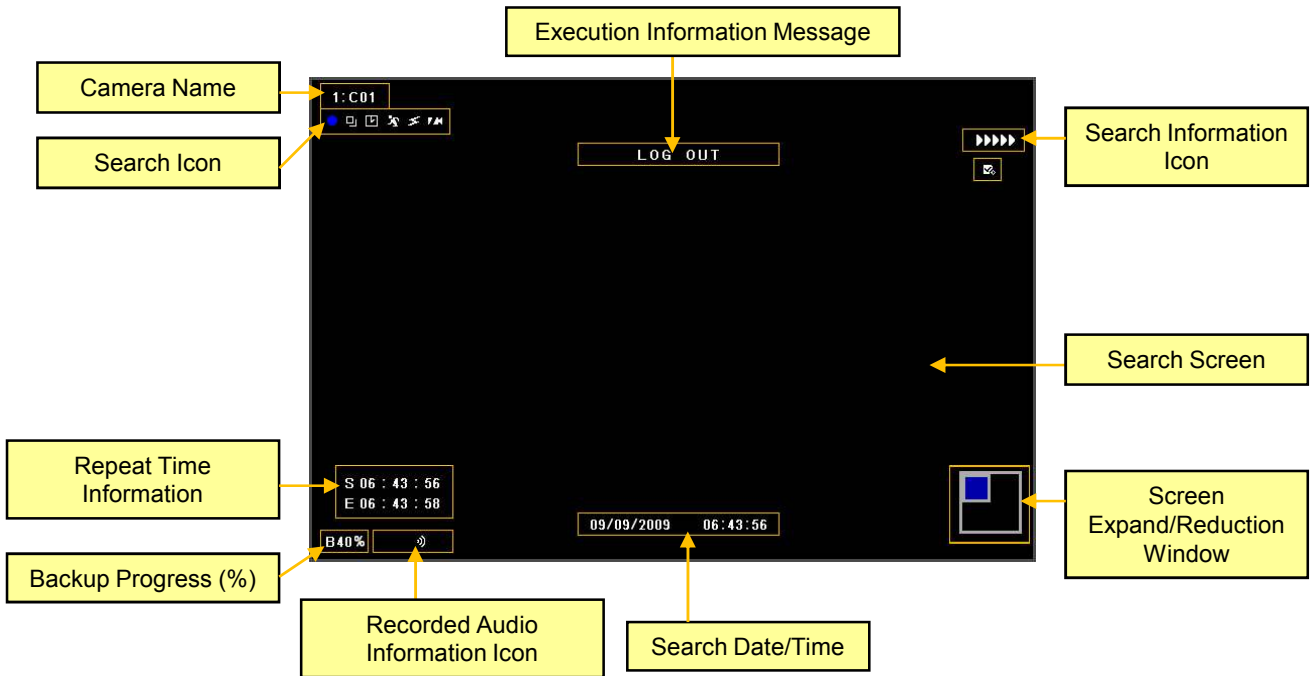

6.1.1 Search Menu

When mouse cursor is placed over on the bottom side, the Search menu is appeared.

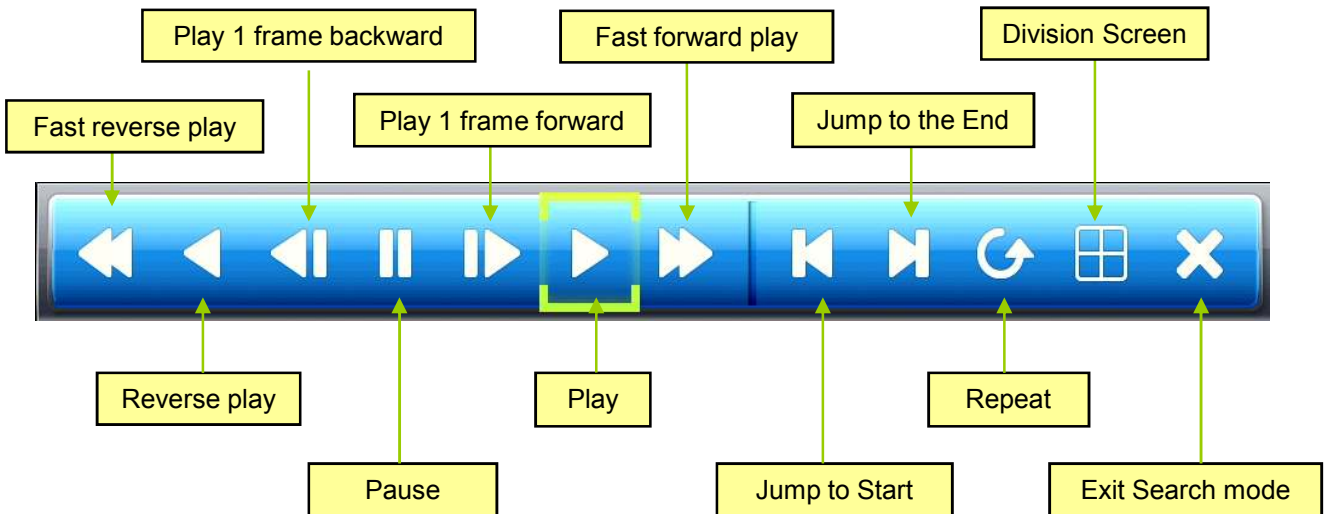

※ As in the live screen, the top menu can be used in the search screen.

6.1.2 CALENDAR SEARCH



- a. Select the data by the direction button.
 - Recorded data is displayed the orange color.



- b. Select the time by the direction button.
 - After select hour, minutes will be appeared.

NOTE: The time graph color is different by the recording mode.
Continuous Recording = Blue, Audio Recording = Light Blue, Event Recording = Red.

6.1.3 EVENT SEARCH

EVENT SEARCH	
EARLIEST RECORD	10/05/2011 16:58:11
LATEST RECORDING	10/10/2011 17:20:16
DATE	10/10/2011
MOTION	ON
ALARM IN	ON
VIDEO LOSS	ON
SELECT CAMERA	ON

VIEW SEARCH LOG

CANCEL

- **DATA** : Select Date to search.
- **MOTION** : Select On/Off event for search.
- **ALARM IN** : Select On/Off event for search.
- **VIDEO LOSS** : Select On/Off event for search.
- **SELECT CAMERA** : Select the camera for search.
- **VIEW SEARCH LOG** : Display selected event log.

NO.	TIME	DST	CAMERA	EVENT

◀ 0 - 23 HOUR ▶

PREV NEXT GOTO

OK CANCEL

- **HOURL** : Select time period to see.
- **PREV** : Display previous page.
- **NEXT** : Display next page.
- **GOTO** : Display the image by selected event.

6.1.4 OVERLAPPED LIST



- If user change the time or applied DST (Daylight Saving Time), there will be overlapped data.



- After select the list, if select the [PLAY] button, can search [QUICK SEARCH] or [EVENT SEARCH].

6.1.5 PANORAMA SEARCH

- During normal search, press the [PANORAMA] button.
- By mouse, click the right mouse button and click the [PANORAMA] Search.
- Playback with frame by frame.

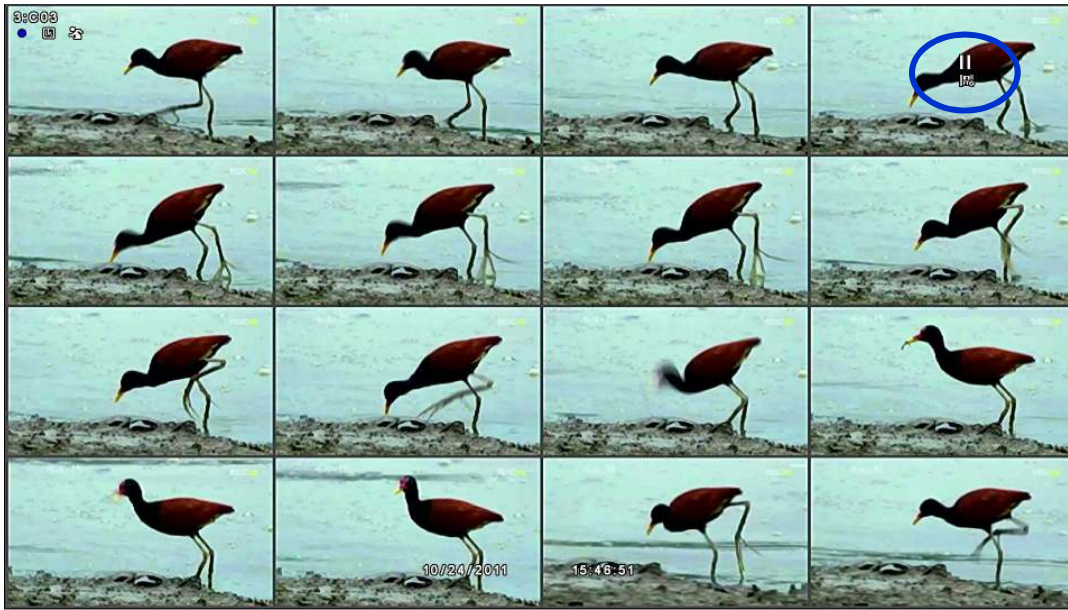

6.1.6 SMART SEARCH

- During normal search, press the [SMART] button.
- Find only event and playback automatically without interval.



6.1.7 SECTION REPEAT SEARCH

- During normal search, press the [LOCK] button.
When press one time, the start position is set, press one more time, the end position is set.
- By mouse, click the below red circle button.
- Only playback the set section repeatedly.



- In search screen, display the following mark.



※ Button Explanation in Search mode

- Remote Controller or Front button

Button	Explanation
SEARCH	Display the [SEARCH] menu.
ESC	Cancel the Search mode or return to the live screen.
ENTER	Select the CAMEO menu.
FAST REVERSE	When reverse play, up and down play speed.
FAST FORWARD	When forward play, up and down play speed.
PAUSE	Pause the playback.
FORWARD PLAY	Playback the data.
REVEERSE PLAY	Reverse Play the data.
DISPLAY	Display division screen. (1,4,9,16)

7. BACKUP

On the Top menu, select the [BACKUP] menu icon.



After select the menu, the following Log-in window will be appeared.

A login window titled "LOGIN" with a blue header. It contains two input fields: "ID" with the value "admin" and "PASSWORD" which is empty. Below the password field is a numeric keypad with buttons for digits 0-9 and a left arrow button. At the bottom are "OK" and "CANCEL" buttons.

LOGIN					
ID		admin			
PASSWORD					
0	1	2	3	4	←
5	6	7	8	9	
OK		CANCEL			

Enter the password by the key buttons and press the ENTER button.

(The default password : 1)

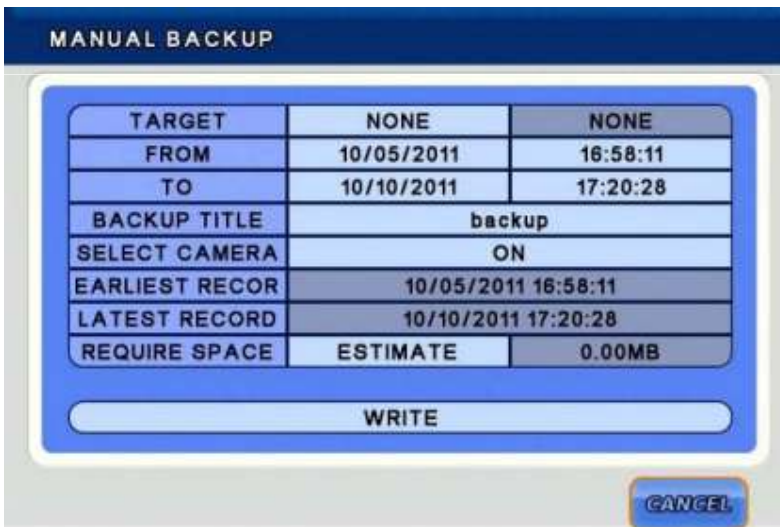
A manual backup configuration window titled "MANUAL BACKUP" with a blue header. It contains a table with backup settings and a "WRITE" button at the bottom. A "CANCEL" button is located at the bottom right.

TARGET	NONE	NONE
FROM	10/05/2011	16:58:11
TO	10/10/2011	17:20:28
BACKUP TITLE	backup	
SELECT CAMERA	ON	
EARLIEST RECOR	10/05/2011 16:58:11	
LATEST RECORD	10/10/2011 17:20:28	
REQUIRE SPACE	ESTIMATE	0.00MB
WRITE		

CANCEL

- **TARGET** : Select the device to backup. (USB / DVD)
- **FROM** : Select the start date and time.
- **TO** : Select the end date and time.
- **BACKUP TITLE** : Type any title.
- **SELECT CAMERA** : Select the camera for backup
- **EARLIEST RECORD** : Display the earliest record.
- **LATEST RECORD** : Display the earliest record.
- **REQUIRE SPACE** : Display the data capacity for selected data.
- **WRITE** : Start the backup.

7.1 Playback with backup data

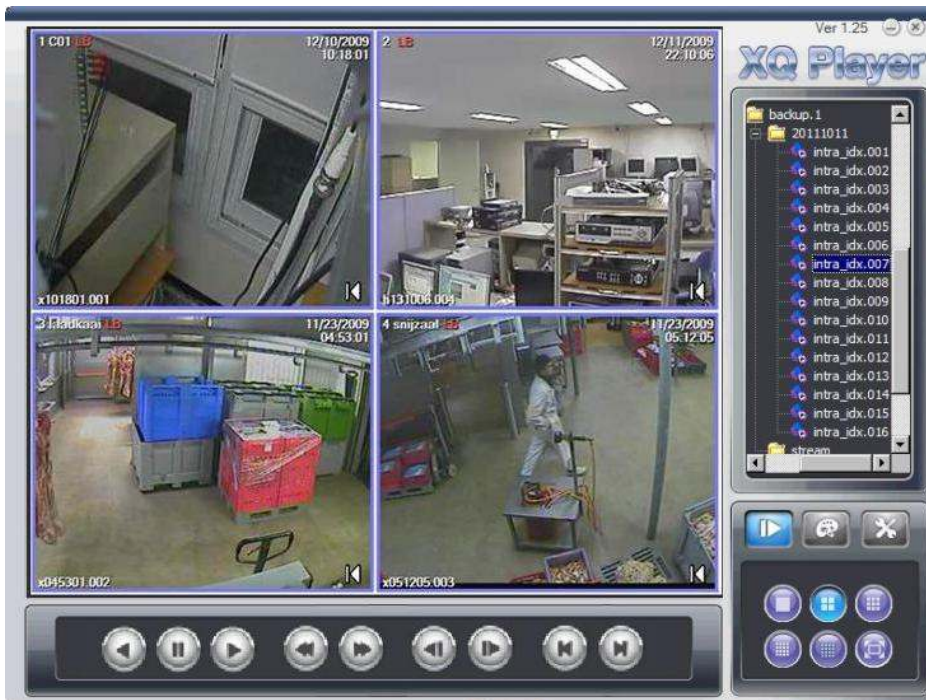

- After backup, the DVR Player is copied with data.
- Backup data only can be played on DVR Player at PC.
- Can export to JPEG still shot.

8. APPENDIX

8.1 Specification

Model	SP-DX1600	SP-DX800
Performance	PENTAPLEX	
Display Speed (NTSC / PAL)	480 / 400 fps	240 / 200 fps
Recording Speed (NTSC / PAL)	CIF (352*240)/(352*288)	480 / 400 fps
	2CIF (704*240)/(704*288)	480 / 400 fps
	D1 (704*480)/(704*576)	480 / 400 fps
Video In	Analog Camera	16 Ch (BNC), 1.0 Vpp Composite (±10%)
	IP Camera	4Ch (Ethernet), Supported SD/HD Class
Video Out	Main Display	1 DVI, 1 Composite(CVBS), 1 VGA(Optional)
	Main Display Resolution	1024x768, 1280x1024, 1680x1050, 1920x1080 selectable
	Loop-Out / Spot	16 Loop Out / 3 Spot
Audio	Input / output	16 Line in / 1 Line out
Alarm	Input / output	8 Line in / 1 Line out
Alarm		
Alarm	Input / output	16 In / 4 Out
Alarm	Input / output	8 In / 1 Out
Details		
Screen	Display Split	1, 4, 7, 9, 10, 13, 16
	Interface	Graphic User Interface
Video	Format	NTSC / PAL Auto detection
	Codec	H.264 Advanced
	Recording type	Schedule / Continuous / Event / Motion / Alarm / Video loss
Storage	Interface type	SATA II
	HDD / Capacity	Internal up to 4 HDD's(Optional) / 8TB External up to 4 HDD's(E-SATA II), Supported External Bay(Optional)
Connectors	USB port	USB port * 2 (A Port: General USB Port, B Port: Dedicated PS/2 Mouse)
Function		
Live Display	OSD	On / Off
	Border Color/ Digital Zoom	Selectable / Up to 4X
	CAMEO	Camera Adjustment / Camera position change / Freeze / Audio on
Motion	Area / Sensitivity	Adjustable GRID (22 X 15) / 5 Level motion detection
System	Hidden Video	Video is hidden in Live view but it is recorded
	Private Zone	Block the private zone in live camera view
	Auto Time Synch	By NTP (Network Time Protocol)
	SMART Alarm	Auto Detect & Monitoring HDD's problem
Event	Source	Motion / Alarm In / Video loss
	Action	E-Mail notification, Log, Send message to Remote, Buzzer, Pop Up, Alarm, PTZ preset
Record	Pre/Post Alarm	Yes (Up to 60 sec / Up to 100 sec)
	Resolution	By each camera for different resolution setting (CIF/2CIF/D1)
Search	Quality	4 Levels (Low / Normal / High / Highest)
	Quick / Event search	Search by time with calendar / Search by event
	Repeat search	Select specific time period and playback repeatedly
	Panorama search	Frame by frame
	Smart search	Search only event and playback without interval
Back Up	CAMEO	Live monitoring during playback, Playback camera change, Freeze and Digital zoom
	file format / Media	DVR Format / DVD or USB device
Network	Protocol	Static IP, DHCP, DDNS
	Physical / Mac Layer	RJ45 (10/100/1000 Mbps), Ethernet
	Browser	SMS, Web Viewer, Smart Phone Viewer (Android, I-phone)
Environment		
Operating Temperature / Humidity	0~40℃ / 20~80% RH	
Dimension / Weight	350(W) X 400(D) X 88(H) / 6Kg (without HDD)	
Power Requirement / Consumption	AC 100V – 220V (50Hz-60Hz) / 60W	

8. APPENDIX

8.2 Trouble Shooting

SYMPTOM	MEASURES
No Power	<p>If the power LED is not lighted, check the below items.</p> <ul style="list-style-type: none"> - Check the power plug and outlet. (Refer to the [Cautions for safety]) - Connect the power cord to the power connector of DVR properly.
No camera image	<ul style="list-style-type: none"> - Connect the camera cable to the DVR port properly. - Check the connected monitor cable with DVR. (Refer to the [Rear Panel Configuration]) - Check the camera power and lens setting. - As this may be caused by a temporary error, restart DVR. - As camera setting may be wrong, initialize the camera and DVR. <p>※ How to initialize DVR</p> <p>1. Main Menu > Configuration > Default Load > O.K > O.K</p> <p>!! Caution: After DVR initialization, DVR setting is returned factory default. Need to backup the configuration before initialize DVR.</p>
Not record on DVR	<p>If the recording LED does not flicker, check the below items.</p> <ul style="list-style-type: none"> - HDD should have enough space otherwise could not be recorded. - Delete data in HDD or change the [HDD OVERWRITE] setting to [ON]. (Refer to the [GENEL Setup] – [HDD OVERWRITE]) - Replace the HDD because the HDD may be failed. - Check the recording setup.
Not connected Network	<p>If the network LED does not flicker, check the below items.</p> <ul style="list-style-type: none"> - Check the connected hub or router. - Check the network cable and connection. - Check the network setup.

<p>Not work remote controller</p>	<ul style="list-style-type: none"> - Check the battery polarity. - Check the remote controller ID. (Refer to the [Remote Controller Configuration]) - Focus on the remote controller to the IR sensor. - Use the remote controller within 7 meters from DVR. - Change the battery.
<p>No sound in live view</p>	<ul style="list-style-type: none"> - Check the mike and audio cable with DVR port. (Refer to the [Real Panel Configuration]) - Check the speaker power which is connected on Audio port. - Turn on the Audio in the CAMEO menu. (Select the channel which is connected Audio and turn on. ※ CAMEO menu will be appear when click the right button of mouse.)
<p>No sound in search</p>	<ul style="list-style-type: none"> - Set to [Audio] – [ON]. (If set to [OFF], sound is not heard during search.) - Although the record icon is lighted, if there is no audio input, sound is not heard. ※ Audio record can be changed [Main Menu] > [Record Setup].
<p>Not work smart search</p>	<ul style="list-style-type: none"> - For smart search, event record should be set. - If event record is not set, when select the smart search, return to the live screen from search mode.